

CONFIDENTIAL

This document is the property of Evapco, Inc. It should not be copied or disclosed without prior written authorization.

| | | | | | |
|----------|--------------------------------|--------------|---------------------|--------|----------------|
| CUSTOMER | MODEL # U-SSTME3-4284H0050F3KA | SCALE N.T.S. | DWG. # USSTM3-SE-24 | REV. 0 | DATE 6/27/2026 |
|----------|--------------------------------|--------------|---------------------|--------|----------------|



NOTES:

- 1) * = HANGER HOLE LOCATION.
- 2) RIGHT HAND MODEL SHOWN.
- 3) HANGER HOLES ARE FOR 3/4 INCH THREADED ROD.
- 4) ALL DIMENSIONS ARE FOR REFERENCE AND SHOULD NOT BE USED FOR PREFABRICATION OF PIPING OR SUPPORTS.

NEMA 4X
JUNCTION BOX

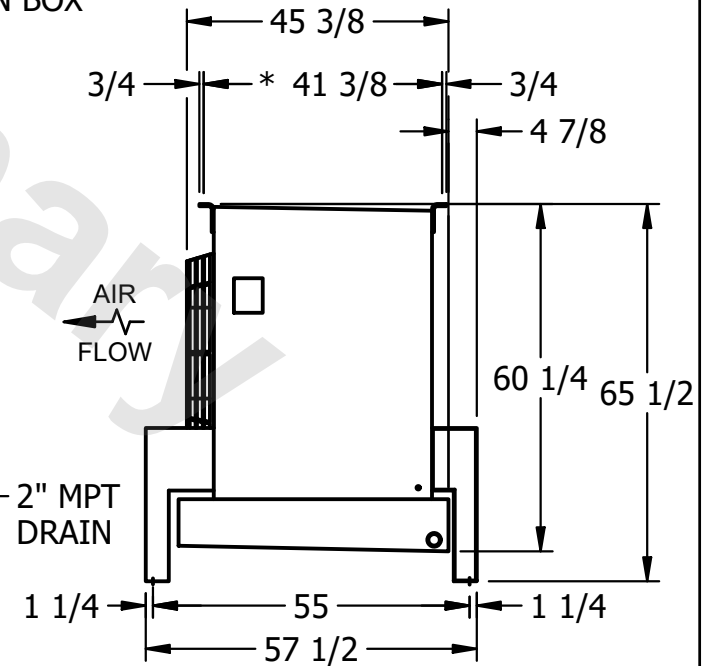

| | | | |
|---------|------|--------------------------------------|---------------------------------------|
| PROJECT | ROOM | SHIPPING WEIGHT 2330 lbs+ [1060] kg+ | OPERATING WEIGHT 2730 lbs+ [1240] kg+ |
|---------|------|--------------------------------------|---------------------------------------|