

CONFIDENTIAL

This document is the property of Evapco, Inc. It should not be copied or disclosed without prior written authorization.

CUSTOMER	MODEL # U-SSTME5-70106F0033F1KA	SCALE N.T.S.	DWG. # USSTM5-SE-24	REV. 0	DATE 4/6/2026
----------	---------------------------------	--------------	---------------------	--------	---------------



NOTES:

- 1) * = HANGER HOLE LOCATION.
- 2) RIGHT HAND MODEL SHOWN.
- 3) HANGER HOLES ARE FOR 3/4 INCH THREADED ROD.
- 4) ALL DIMENSIONS ARE FOR REFERENCE AND SHOULD NOT BE USED FOR PREFABRICATION OF PIPING OR SUPPORTS.



NEMA 4X
JUNCTION BOX



2" MPT
DRAIN

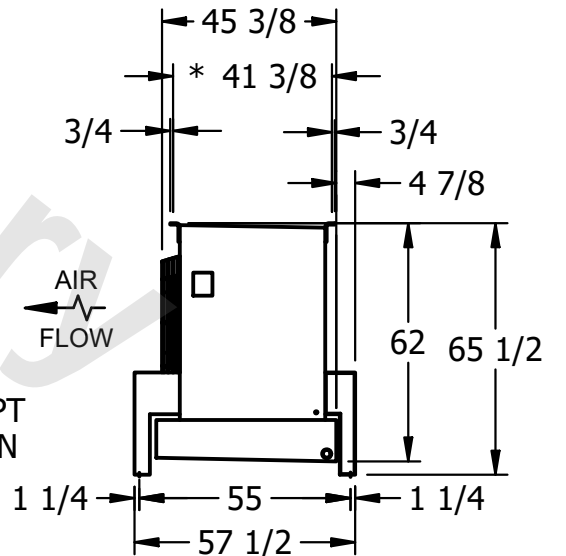

PROJECT	ROOM	SHIPPING WEIGHT 3750 lbs+ [1705] kg+	OPERATING WEIGHT 4820 lbs+ [2190] kg+
---------	------	--------------------------------------	---------------------------------------