

CONFIDENTIAL

This document is the property of Evapco, Inc. It should not be copied or disclosed without prior written authorization.

CUSTOMER	MODEL # U-SSTME4-37103H0200F1LA	SCALE N.T.S.	DWG. # USSTM4-SE-16,18	REV. 0	DATE 4/26/2026
----------	---------------------------------	--------------	------------------------	--------	----------------

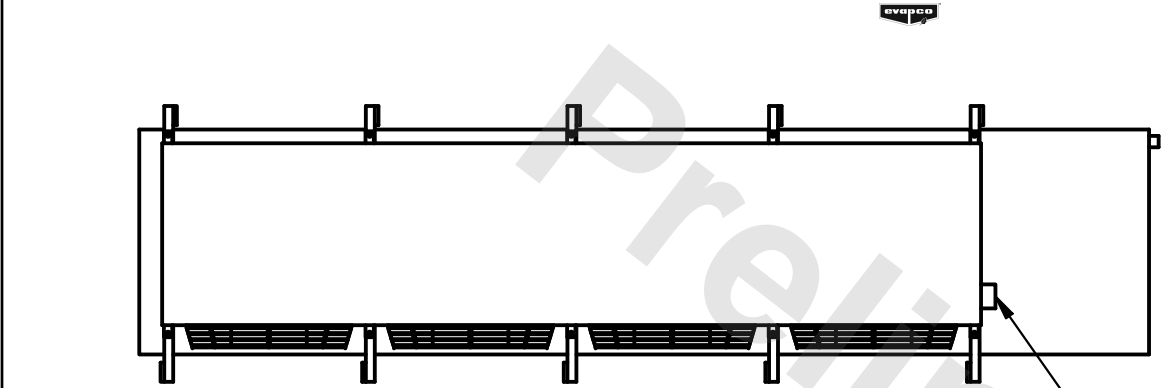

NOTES:

- 1) * = HANGER HOLE LOCATION.
- 2) RIGHT HAND MODEL SHOWN.
- 3) HANGER HOLES ARE FOR 3/4 INCH THREADED ROD.
- 4) ALL DIMENSIONS ARE FOR REFERENCE AND SHOULD NOT BE USED FOR PREFABRICATION OF PIPING OR SUPPORTS.

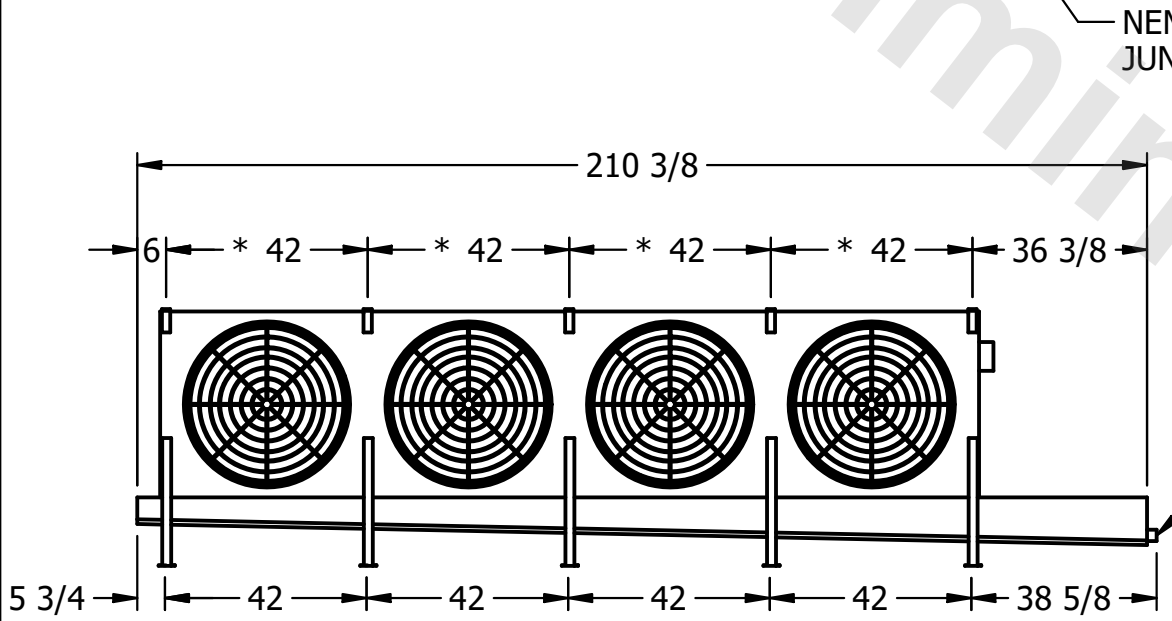

NEMA 4X JUNCTION BOX

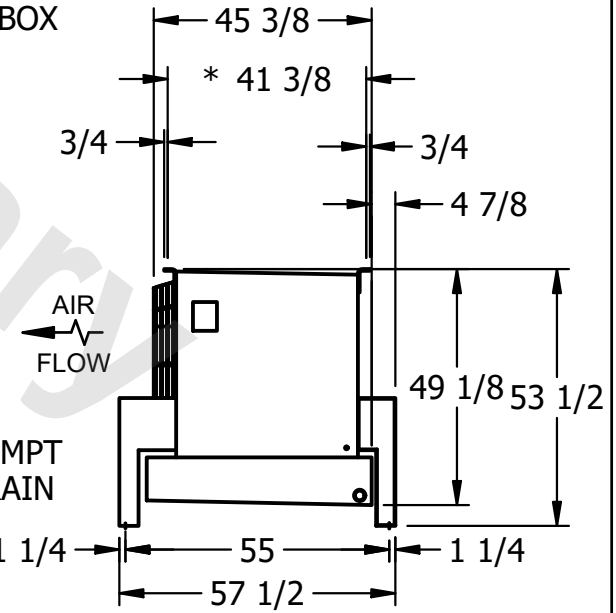

PROJECT	ROOM	SHIPPING WEIGHT 2540 lbs+ [1155] kg+	OPERATING WEIGHT 2910 lbs+ [1320] kg+
---------	------	--------------------------------------	---------------------------------------