

CONFIDENTIAL

This document is the property of Evapco, Inc. It should not be copied or disclosed without prior written authorization.

CUSTOMER	MODEL # U-SSTME3-3286F0200F1LA	SCALE N.T.S.	DWG. # USSTM3-SE-16,18	REV. 0	DATE 4/30/2026
----------	--------------------------------	--------------	------------------------	--------	----------------



- NOTES:**
- 1) * = HANGER HOLE LOCATION.
 - 2) RIGHT HAND MODEL SHOWN.
 - 3) HANGER HOLES ARE FOR 3/4 INCH THREADED ROD.
 - 4) ALL DIMENSIONS ARE FOR REFERENCE AND SHOULD NOT BE USED FOR PREFABRICATION OF PIPING OR SUPPORTS.

NEMA 4X
JUNCTION BOX

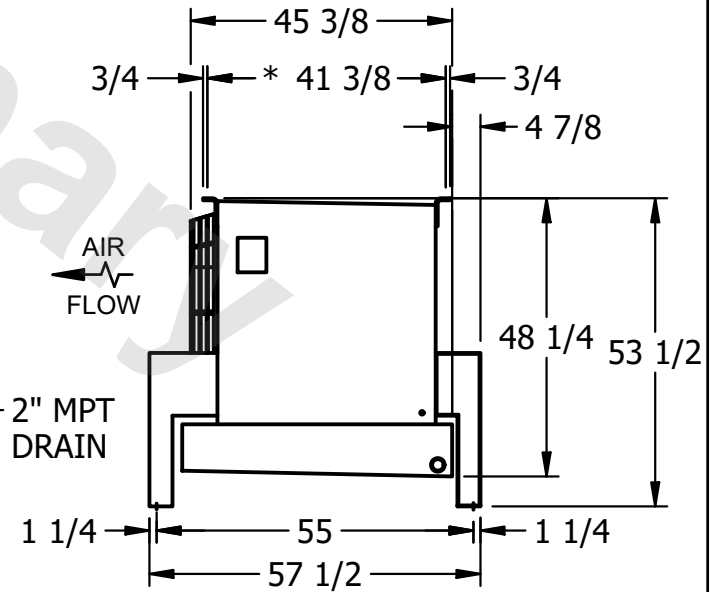

PROJECT	ROOM	SHIPPING WEIGHT 1780 lbs+ [810] kg+	OPERATING WEIGHT 2170 lbs+ [985] kg+
---------	------	-------------------------------------	--------------------------------------