

CONFIDENTIAL

This document is the property of Evapco, Inc. It should not be copied or disclosed without prior written authorization.

CUSTOMER	MODEL # U-SSTME2-28104H0100F1KA	SCALE N.T.S.	DWG. # USSTM2-SE-24	REV. 0	DATE 6/26/2026
----------	---------------------------------	--------------	---------------------	--------	----------------



NOTES:

- 1) * = HANGER HOLE LOCATION.
- 2) RIGHT HAND MODEL SHOWN.
- 3) HANGER HOLES ARE FOR 3/4 INCH THREADED ROD.
- 4) ALL DIMENSIONS ARE FOR REFERENCE AND SHOULD NOT BE USED FOR PREFABRICATION OF PIPING OR SUPPORTS.

NEMA 4X
JUNCTION BOX



2" MPT
DRAIN

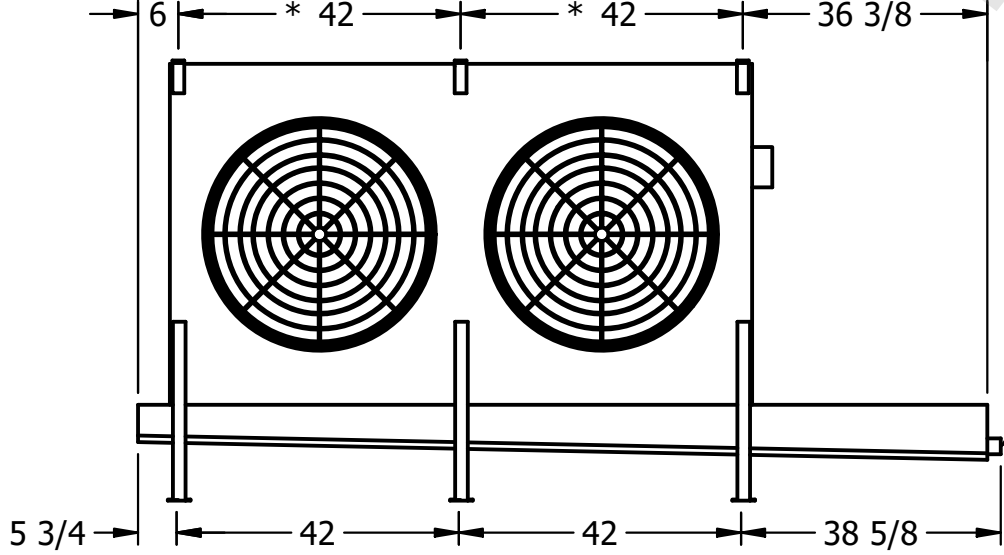

PROJECT	ROOM	SHIPPING WEIGHT 1830 lbs+ [835] kg+	OPERATING WEIGHT 2160 lbs+ [980] kg+
---------	------	-------------------------------------	--------------------------------------