

UNIT	CONDENSER	
MODEL #	PMRC-1549	SCALE NTS

EVAPCO, INC.



DWG. #	CEWR123610-DRA-ST	REV	-
SERIAL #		DATE:	4/25/2026

NOTES:

- (M)- FAN MOTOR LOCATION.
- MPT DENOTES MALE PIPE THREAD
FPT DENOTES FEMALE PIPE THREAD
BFW DENOTES BEVELED FOR WELDING
GVD DENOTES GROOVED
FLG DENOTES FLANGE
PE DENOTES PLAIN END
- +UNIT WEIGHT DOES NOT INCLUDE ACCESSORIES (SEE ACCESSORY DRAWINGS).
- 3/4" [19mm] DIA. MOUNTING HOLES. REFER TO RECOMMENDED STEEL SUPPORT DRAWING.
- MAKE-UP WATER PRESSURE 20 psi [137 kPa] MIN, 50 psi [344 kPa] MAX.
- DIMENSIONS LISTED AS FOLLOWS:
ENGLISH FT-IN
[METRIC] [mm]
- * - APPROXIMATE DIMENSIONS DO NOT USE FOR PRE-FABRICATION OF CONNECTING PIPING.

FACE B
PLAN VIEW

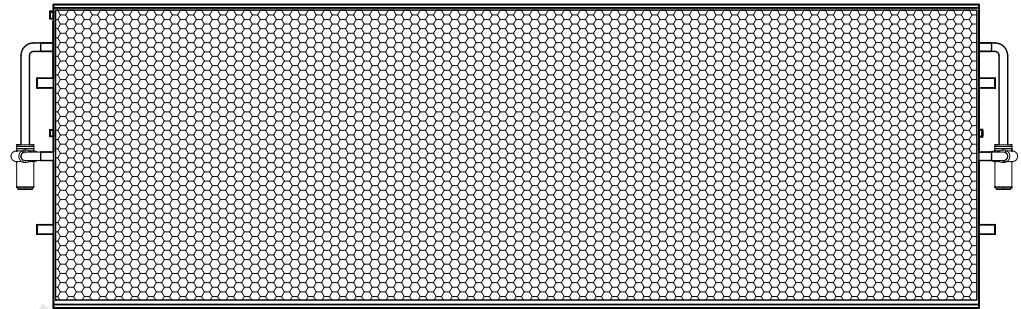

FACE C

FACE D

FACE A

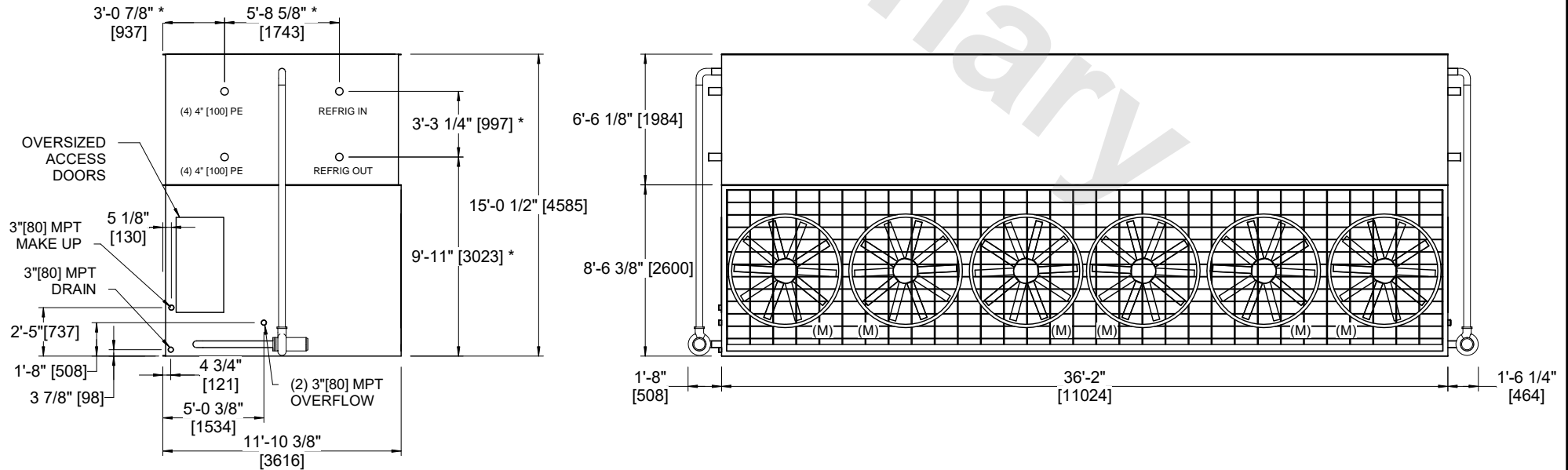

FACE B

FACE A

SHIPPING WEIGHT	59000 lbs+ [26765] kg+	OPERATING WEIGHT	73900 lbs+ [33525] kg+	HEAVIEST SECTION WEIGHT	21790 lbs+ [9885] kg+	NO. OF SHIPPING SECTIONS	3	DRAWN BY:	JLG
-----------------	------------------------	------------------	------------------------	-------------------------	-----------------------	--------------------------	---	-----------	-----