

UNIT	CONDENSER	
MODEL #	eco-PMRC-1482	SCALE NTS

EVAPCO, INC.



DWG. #	CEWR123612-DRA-ST	REV	-
SERIAL #		DATE:	6/20/2026

- NOTES:**
- (M)- FAN MOTOR LOCATION.
 - MPT DENOTES MALE PIPE THREAD
FPT DENOTES FEMALE PIPE THREAD
BFW DENOTES BEVELED FOR WELDING
GVD DENOTES GROOVED
FLG DENOTES FLANGE
PE DENOTES PLAIN END
 - +UNIT WEIGHT DOES NOT INCLUDE ACCESSORIES (SEE ACCESSORY DRAWINGS).
 - 3/4" [19mm] DIA. MOUNTING HOLES. REFER TO RECOMMENDED STEEL SUPPORT DRAWING.
 - MAKE-UP WATER PRESSURE 20 psi [137 kPa] MIN, 50 psi [344 kPa] MAX.
 - DIMENSIONS LISTED AS FOLLOWS:
ENGLISH FT-IN
[METRIC] [mm]
 - * - APPROXIMATE DIMENSIONS DO NOT USE FOR PRE-FABRICATION OF CONNECTING PIPING.

FACE B
PLAN VIEW

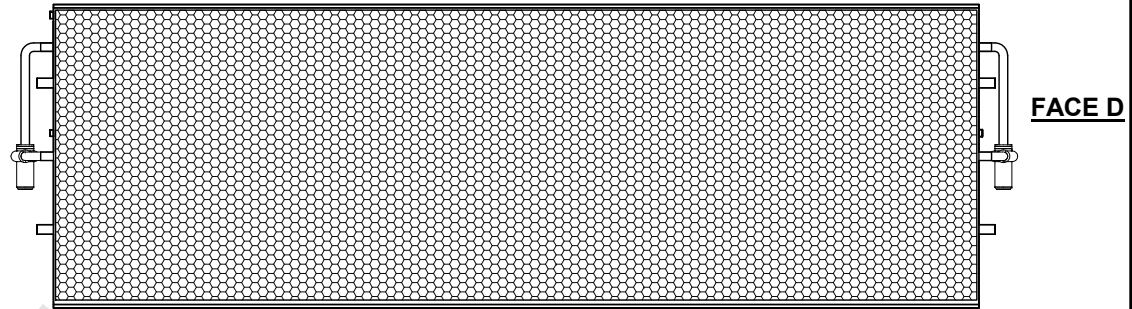

FACE A

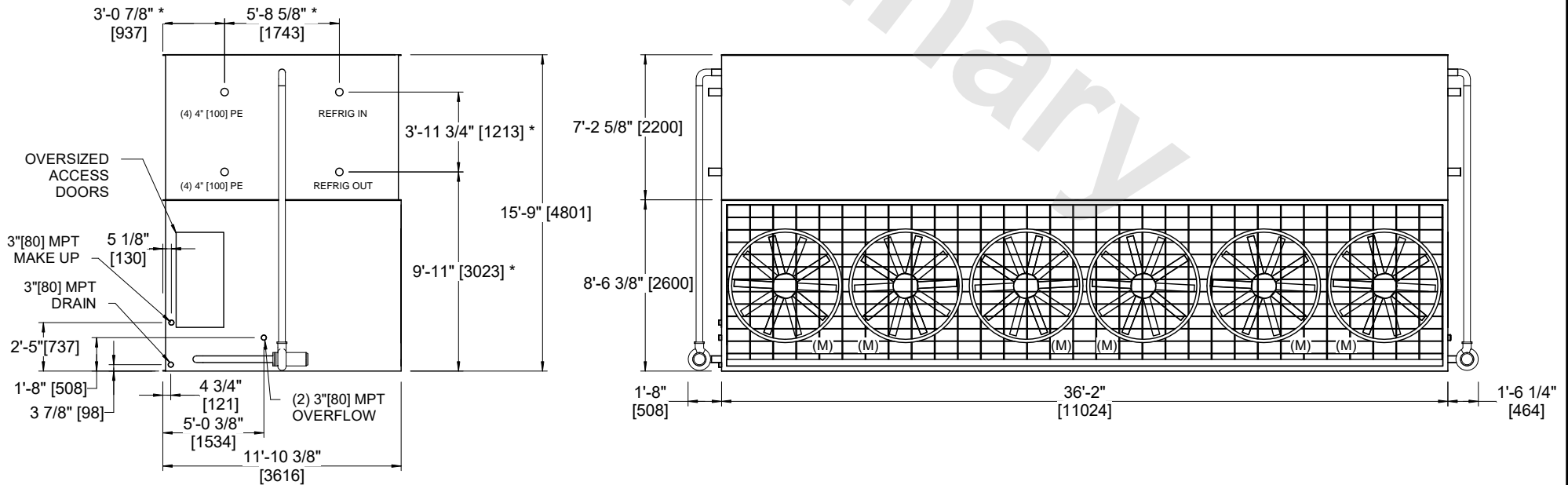

FACE B

FACE A

SHIPPING WEIGHT	81850 lbs+ [37130] kg+	OPERATING WEIGHT	97040 lbs+ [44020] kg+	HEAVIEST SECTION WEIGHT	33470 lbs+ [15185] kg+	NO. OF SHIPPING SECTIONS	3	DRAWN BY:	JLG
-----------------	------------------------	------------------	------------------------	-------------------------	------------------------	--------------------------	---	-----------	-----