

CONFIDENTIAL
 This document is the property of Evapco, Inc. It should not be copied or disclosed without prior written authorization.

EVAPCO, INC.



CUSTOMER	MODEL # EJETHE2-4564F0750K1LA	SCALE N.T.S.	DWG. # EJETHE2-SE-24	REV. 0	DATE 6/20/2026
----------	-------------------------------	--------------	----------------------	--------	----------------

NOTES:

- 1) * = HANGER HOLE LOCATION.
 **= FOOT PLATE MOUNTING HOLE LOCATION
- 2) RIGHT HAND MODEL SHOWN.
- 3) HANGER HOLES ARE FOR 3/4 INCH THREADED ROD.
- 4) WATER DEFROST ADDS 6" INCHES TO HEIGHT OF STANDARD UNIT AND CHANGES DRAIN SIZE.
- 5) ALL DIMENSIONS ARE FOR REFERENCE AND SHOULD NOT BE USED FOR PREFABRICATION OF PIPING OR SUPPORTS.
- 6) ***= HEIGHT OF SUCTION HEADER AND INSTALLED THERMOWELL FITTING ABOVE CABINET. CUSTOMER IS RESPONSIBLE TO ACCOUNT FOR ADDITIONAL HEIGHT NECESSARY FOR RTD AND ACCESS.



NEMA 4X
 JUNCTION
 BOX

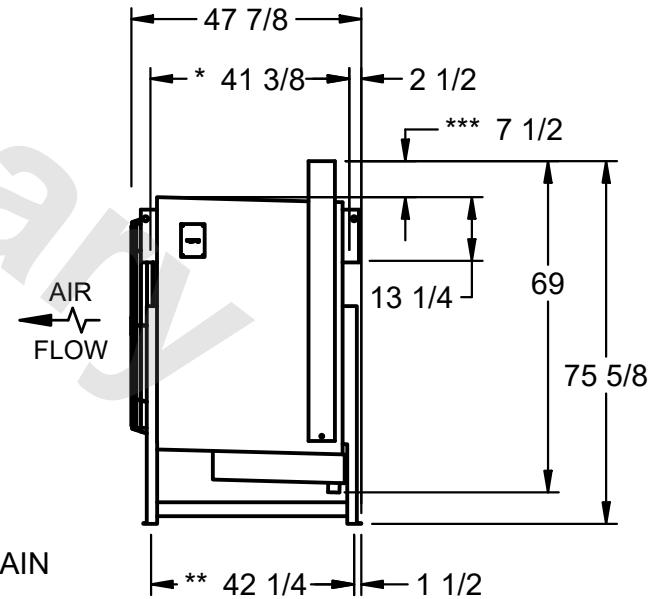

2" MPT DRAIN

PROJECT	ROOM	SHIPPING WEIGHT 2750 lbs	OPERATING WEIGHT 3070 lbs
---------	------	--------------------------	---------------------------