

**CONFIDENTIAL**

This document is the property of Evapco, Inc. It should not be copied or disclosed without prior written authorization.

# EVAPCO, INC.



CUSTOMER	MODEL # EJETHE4-13483H0500K1LA	SCALE N.T.S.	DWG. # EJETHE4-SE-36	REV. 0	DATE 4/6/2026
----------	--------------------------------	--------------	----------------------	--------	---------------

**NOTES:**

- 1) \* = HANGER HOLE LOCATION.  
\*\* = FOOT PLATE MOUNTING HOLE LOCATION
- 2) RIGHT HAND MODEL SHOWN.
- 3) HANGER HOLES ARE FOR 3/4 INCH THREADED ROD.
- 4) WATER DEFROST ADDS 6" INCHES TO HEIGHT OF STANDARD UNIT AND CHANGES DRAIN SIZE.
- 5) ALL DIMENSIONS ARE FOR REFERENCE AND SHOULD NOT BE USED FOR PREFABRICATION OF PIPING OR SUPPORTS.
- 6) \*\*\* = HEIGHT OF SUCTION HEADER AND INSTALLED THERMOWELL FITTING ABOVE CABINET. CUSTOMER IS RESPONSIBLE TO ACCOUNT FOR ADDITIONAL HEIGHT NECESSARY FOR RTD AND ACCESS.

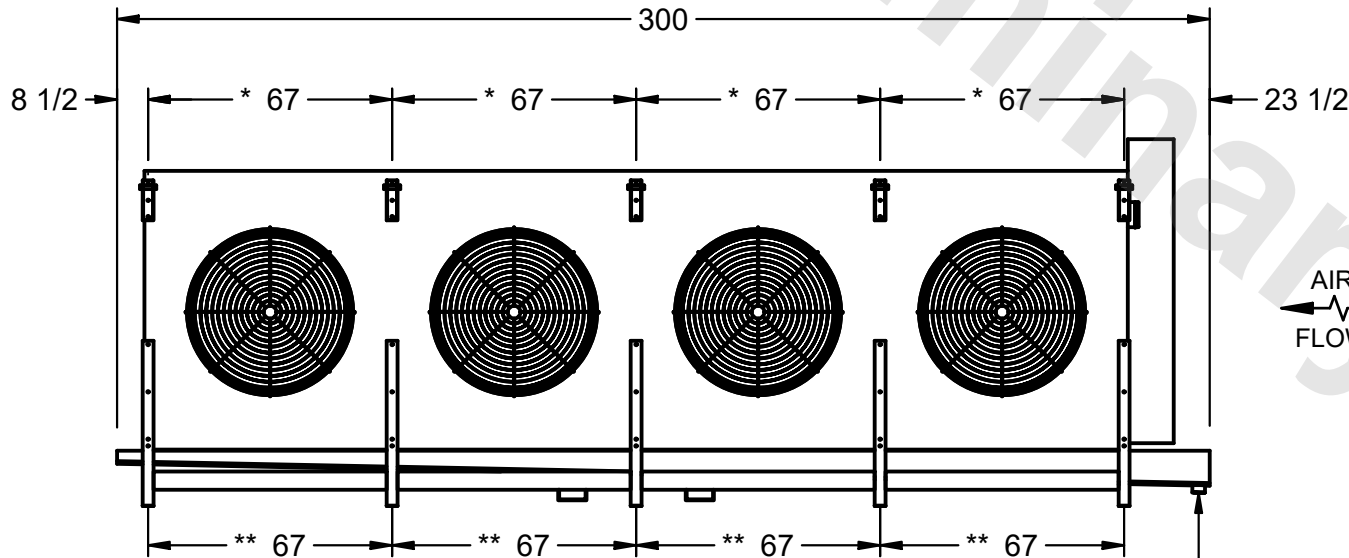

NEMA 4X  
JUNCTION  
BOX

AIR  
FLOW



PROJECT	ROOM	SHIPPING WEIGHT 6860 lbs	OPERATING WEIGHT 7920 lbs
---------	------	--------------------------	---------------------------