

**CONFIDENTIAL**

This document is the property of Evapco, Inc. It should not be copied or disclosed without prior written authorization.

# EVAPCO, INC.



|          |                              |              |                    |        |                |
|----------|------------------------------|--------------|--------------------|--------|----------------|
| CUSTOMER | MODEL # SSTXB5-3586F0100A1MA | SCALE N.T.S. | DWG. # STXC5-SE-12 | REV. 1 | DATE 5/17/2022 |
|----------|------------------------------|--------------|--------------------|--------|----------------|



**NOTES:**

- 1) \* = HANGER HOLE LOCATION.
- 2) RIGHT HAND MODEL SHOWN.
- 3) HANGER HOLES ARE FOR 3/4 INCH THREADED ROD.
- 4) WATER DEFROST ADDS 6 1/2" INCHES TO HEIGHT AND 5" INCHES TO WIDTH OF STANDARD UNIT AND CHANGES THE DRAIN SIZE.
- 5) ALL DIMENSIONS ARE FOR REFERENCE AND SHOULD NOT BE USED FOR PREFABRICATION OF PIPING OR SUPPORTS.

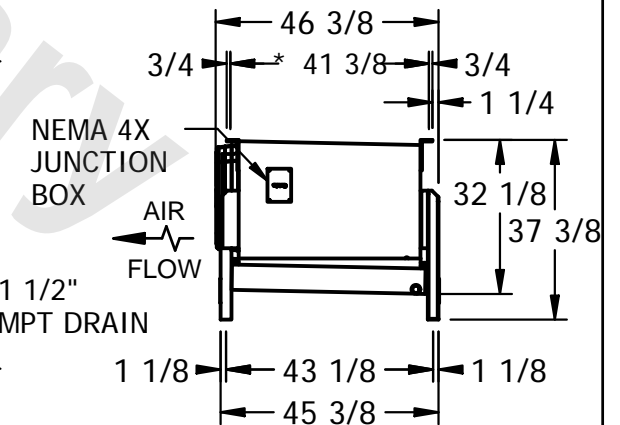

|         |      |                          |                           |
|---------|------|--------------------------|---------------------------|
| PROJECT | ROOM | SHIPPING WEIGHT 2210 lbs | OPERATING WEIGHT 2630 lbs |
|---------|------|--------------------------|---------------------------|