

EVAPCO, INC.

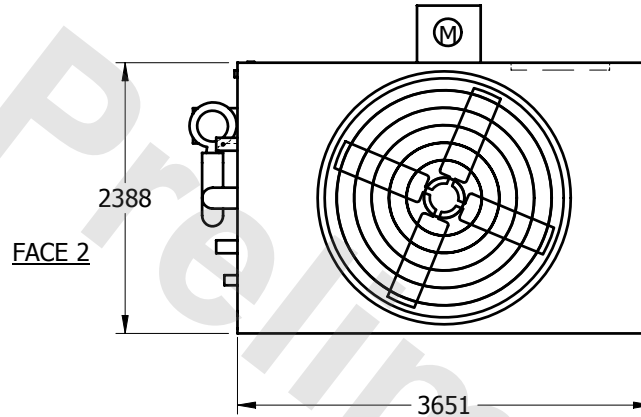

UNIT	CLOSED CIRCUIT COOLER	MODEL #	MTC-106A	SCALE	NTS	DWG. #	WX2M123612-MRA-SF	REV.		DATE	5/26/2022	SERIAL #	
-------------	------------------------------	----------------	----------	--------------	-----	---------------	-------------------	-------------	--	-------------	-----------	-----------------	--

- NOTES:
1. (M)- FAN MOTOR LOCATION
 2. HEAVIEST SECTION IS LOWER SECTION
 3. MPT DENOTES MALE PIPE THREAD
FPT DENOTES FEMALE PIPE THREAD
BFW DENOTES BEVELED FOR WELDING
 4. † UNIT WEIGHT DOES NOT INCLUDE ACCESSORIES (SEE SEPARATE DRAWINGS FOR ACCESSORIES)
 5. 19mm DIA. MOUNTING HOLES. REFER TO RECOMMENDED STEEL SUPPORT DRAWING
 6. MAKE-UP WATER PRESSURE-137 kPa MIN, 344 kPa MAX
 7. *- APPROXIMATE DIMENSIONS DO NOT USE FOR PRE-FABRICATION OF CONNECTING PIPING
 8. MAKE-UP IS LOCATED 121mm FROM CONNECTION END
 9. SERIES FLOW CROSSOVER PIPING PROVIDED INTERNALLY



FACE 1
PLAN VIEW

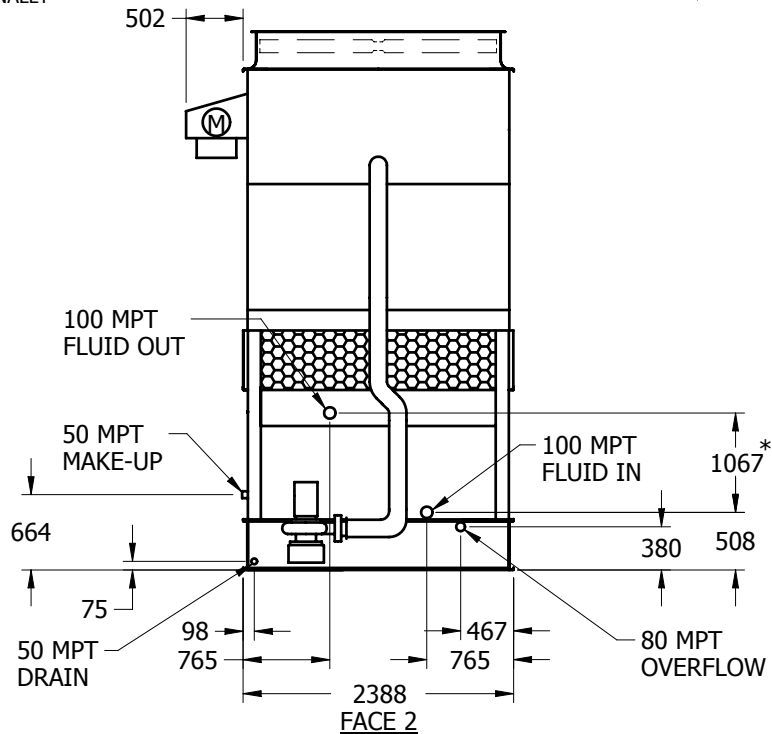

FACE 2

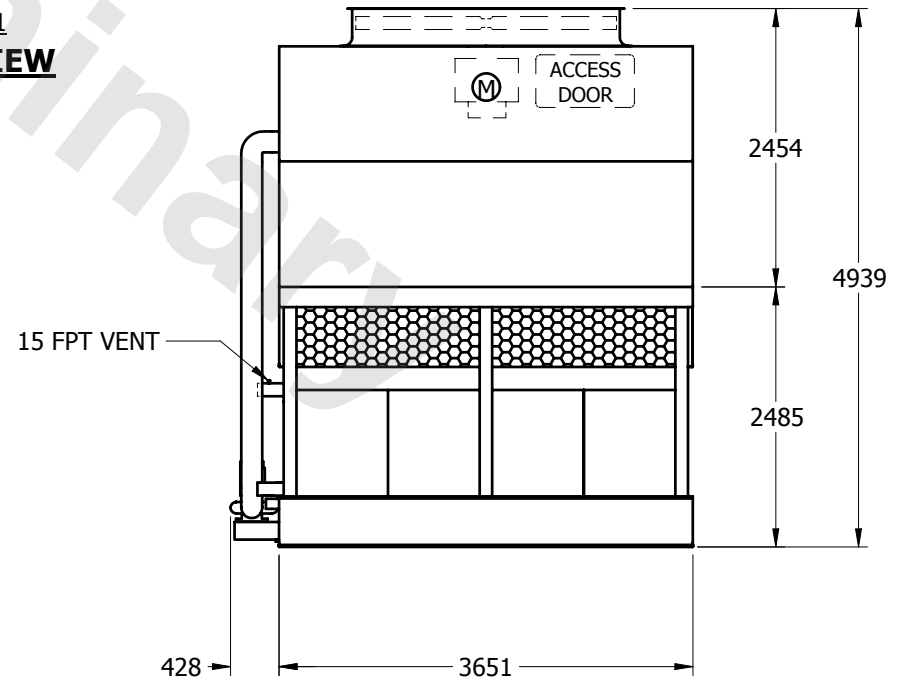

FACE 1

SHIPPING WEIGHT	5475	kg †	OPERATING WEIGHT	8075	kg	HEAVIEST SECTION WEIGHT	3945	kg	NO. OF SHIPPING SECTIONS	2
------------------------	------	-------------	-------------------------	------	-----------	--------------------------------	------	-----------	---------------------------------	---