

EVAPCO, INC.

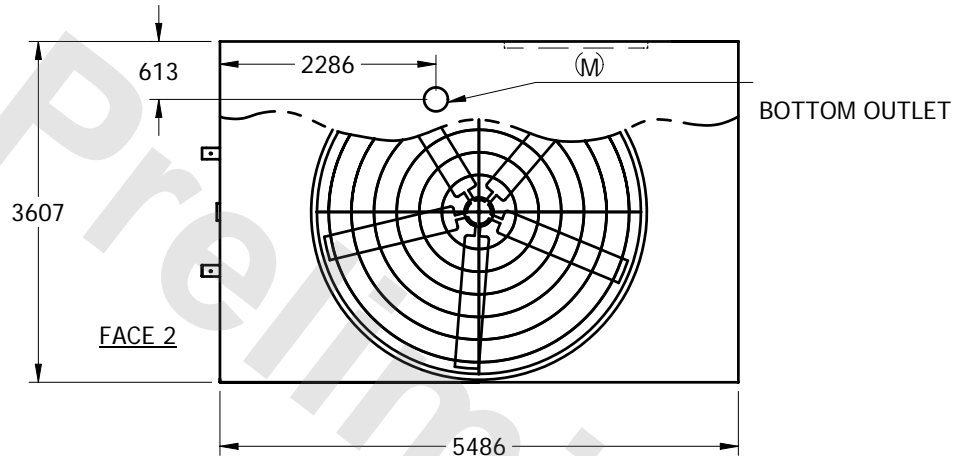

UNIT	CLOSED CIRCUIT COOLER	MODEL #	PMC-989E	SCALE	NTS	DWG. #	WX12182410-MRD-RS	REV.		DATE	10/23/2021	SERIAL #	
------	------------------------------	---------	----------	-------	-----	--------	-------------------	------	--	------	------------	----------	--

- NOTES:
1. (M)- FAN MOTOR LOCATION
 2. HEAVIEST SECTION IS LOWER SECTION
 3. MPT DENOTES MALE PIPE THREAD
FPT DENOTES FEMALE PIPE THREAD
BFW DENOTES BEVELED FOR WELDING
 4. + UNIT WEIGHT DOES NOT INCLUDE ACCESSORIES (SEE SEPARATE DRAWINGS FOR ACCESSORIES)
 5. 19mm DIA. MOUNTING HOLES. REFER TO RECOMMENDED STEEL SUPPORT DRAWING
 6. THE SPRAY PUMP SHOULD BE SIZED FOR 65 L/S AND 25 kPa AT THE INLET CONNECTION
 7. *- APPROXIMATE DIMENSIONS DO NOT USE FOR PRE-FABRICATION OF CONNECTING PIPING



PLAN VIEW

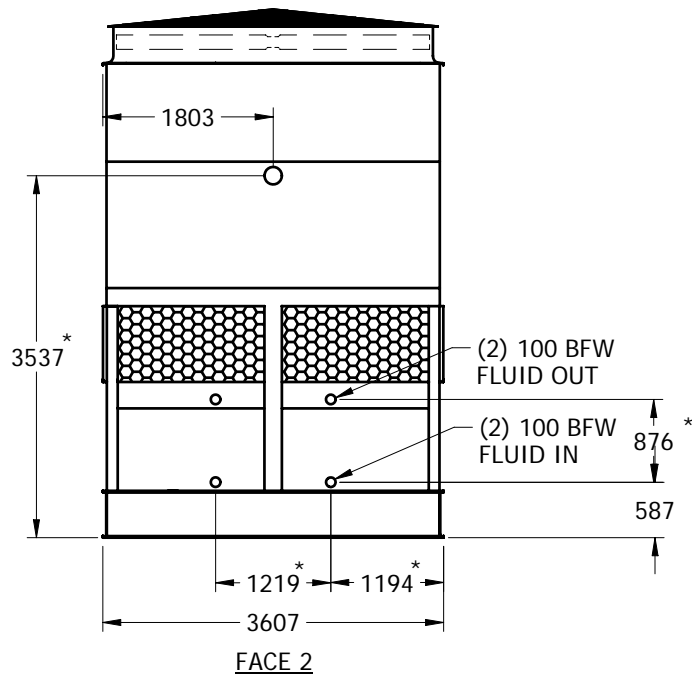

FACE 2

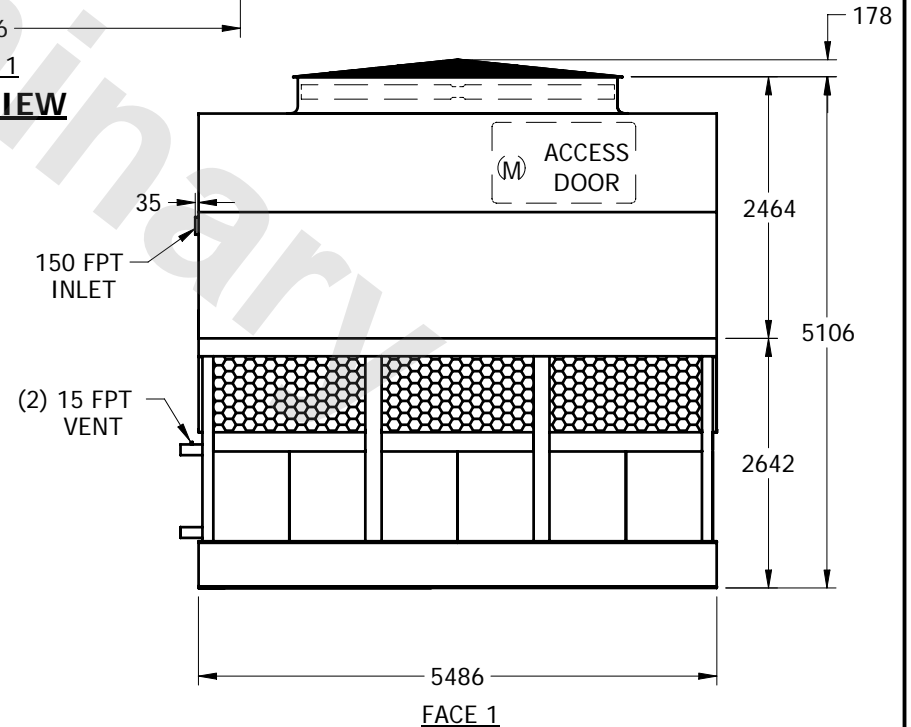

FACE 1

SHIPPING WEIGHT	10330	kg +	OPERATING WEIGHT	13355	kg	HEAVIEST SECTION WEIGHT	7195	kg	NO. OF SHIPPING SECTIONS	2
-----------------	-------	------	------------------	-------	----	-------------------------	------	----	--------------------------	---