

# EVAPCO, INC.

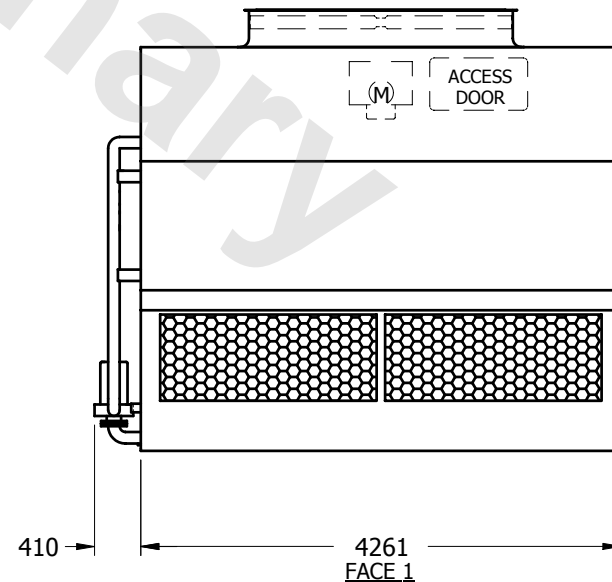

<b>UNIT</b>	<b>EVAPORATIVE CONDENSER</b>	<b>MODEL #</b>	PMC-992E	<b>SCALE</b>	NTS	<b>DWG. #</b>	C2091412-MRC-LF	<b>REV.</b>		<b>DATE</b>	11/7/2024	<b>SERIAL #</b>	
-------------	------------------------------	----------------	----------	--------------	-----	---------------	-----------------	-------------	--	-------------	-----------	-----------------	--

- NOTES:
- (M)- FAN MOTOR LOCATION
  - HEAVIEST SECTION IS UPPER SECTION
  - MPT DENOTES MALE PIPE THREAD  
FPT DENOTES FEMALE PIPE THREAD  
BFW DENOTES BEVELED FOR WELDING
  - + UNIT WEIGHT DOES NOT INCLUDE ACCESSORIES (SEE SEPARATE DRAWINGS FOR ACCESSORIES)
  - 19mm DIA. MOUNTING HOLES. REFER TO RECOMMENDED STEEL SUPPORT DRAWING
  - MAKE-UP WATER PRESSURE-137 kPa MIN, 344 kPa MAX
  - \*- APPROXIMATE DIMENSIONS DO NOT USE FOR PRE-FABRICATION OF CONNECTING PIPING
  - MAKE-UP IS LOCATED 121mm FROM CONNECTION END

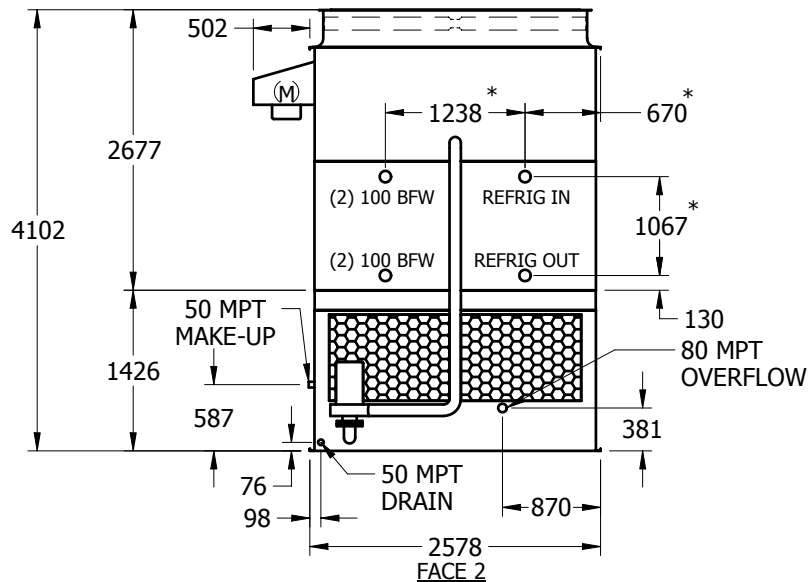
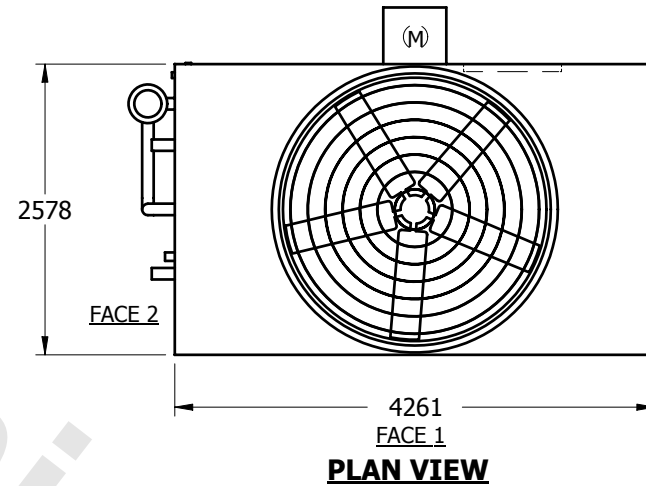

<b>SHIPPING WEIGHT</b>	8135	<b>kg +</b>	<b>OPERATING WEIGHT</b>	10630	<b>kg</b>	<b>HEAVIEST SECTION WEIGHT</b>	7215	<b>kg</b>	<b>NO. OF SHIPPING SECTIONS</b>	2
------------------------	------	-------------	-------------------------	-------	-----------	--------------------------------	------	-----------	---------------------------------	---