

EVAPCO, INC.

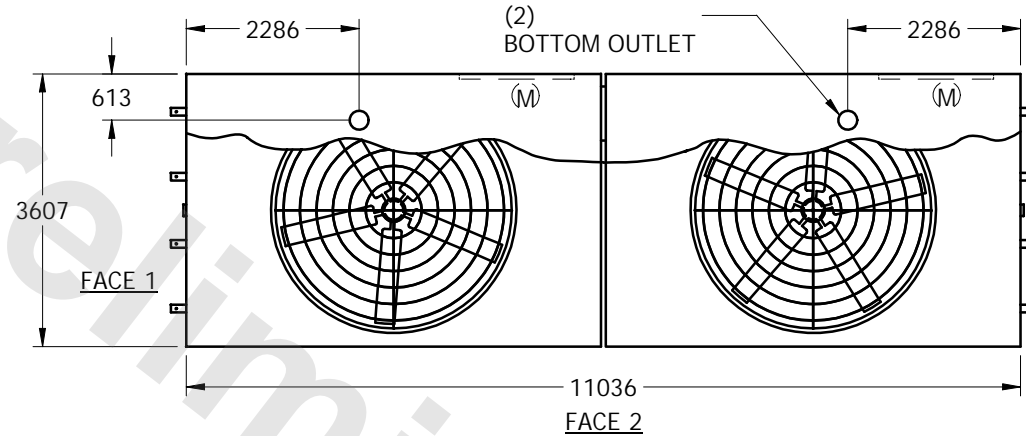

UNIT	CLOSED CIRCUIT COOLER	MODEL #	PMC-992E	SCALE	NTS	DWG. #	W2123606-MRC-LFHR	REV.		DATE	11/7/2024	SERIAL #	
------	-----------------------	---------	----------	-------	-----	--------	-------------------	------	--	------	-----------	----------	--

- NOTES:
- (M)- FAN MOTOR LOCATION
 - HEAVIEST SECTION IS UPPER SECTION
 - MPT DENOTES MALE PIPE THREAD
FPT DENOTES FEMALE PIPE THREAD
BFW DENOTES BEVELED FOR WELDING
 - + UNIT WEIGHT DOES NOT INCLUDE ACCESSORIES (SEE SEPARATE DRAWINGS FOR ACCESSORIES)
 - 19mm DIA. MOUNTING HOLES. REFER TO RECOMMENDED STEEL SUPPORT DRAWING
 - THE SPRAY PUMP SHOULD BE SIZED FOR 151 L/S AND 17 kPa AT THE INLET CONNECTION
 - *- APPROXIMATE DIMENSIONS DO NOT USE FOR PRE-FABRICATION OF CONNECTING PIPING



PLAN VIEW

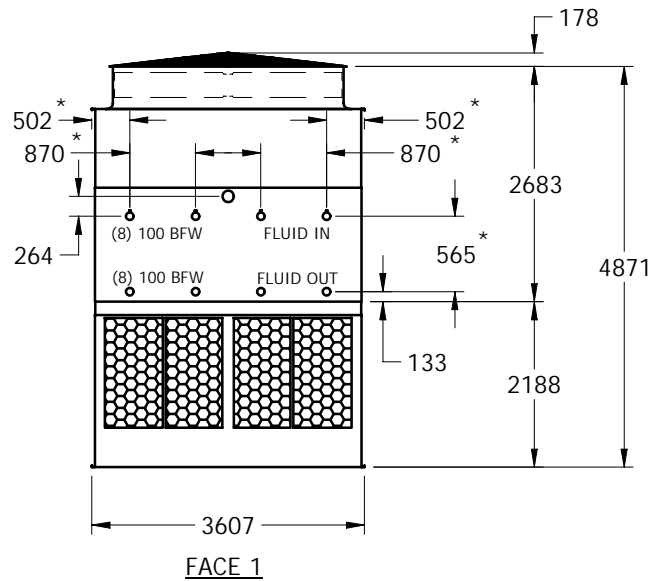

FACE 1

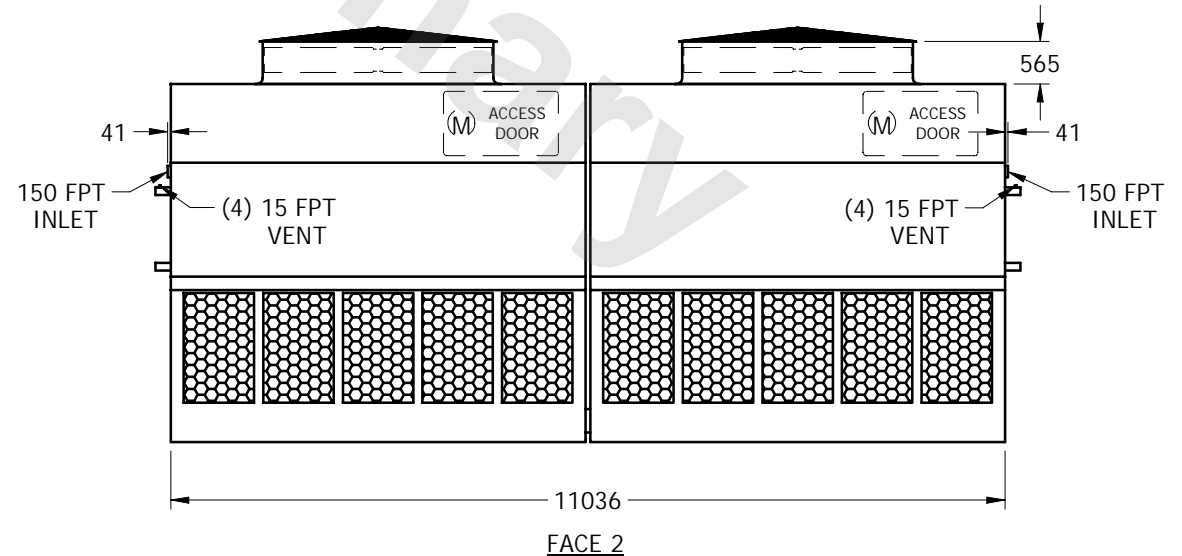

FACE 2

SHIPPING WEIGHT	19540	kg +	OPERATING WEIGHT	26260	kg	HEAVIEST SECTION WEIGHT	7985	kg	NO. OF SHIPPING SECTIONS	4
-----------------	-------	------	------------------	-------	----	-------------------------	------	----	--------------------------	---