

UNIT	COOLING TOWER	
MODEL #	SUN-19-611	SCALE NTS

EVAPCO, INC.

DWG. #	T3091148-DRB-SUN	REV.	-
SERIAL #		DATE	4/14/2021

- NOTES:
- (M)- FAN MOTOR LOCATION
 - HEAVIEST SECTION IS UPPER SECTION
 - MPT DENOTES MALE PIPE THREAD
FPT DENOTES FEMALE PIPE THREAD
BFW DENOTES BEVELED FOR WELDING
GVD DENOTES GROOVED
FLG DENOTES FLANGE
 - +UNIT WEIGHT DOES NOT INCLUDE ACCESSORIES (SEE ACCESSORY DRAWINGS)
 - MAKE-UP WATER PRESSURE
20 psi MIN [137 kPa], 50 psi MAX [344 kPa]
 - 3/4" [19MM] DIA. MOUNTING HOLES. REFER TO RECOMENDED STEEL SUPPORT DRAWING.
 - DIMENSIONS LISTED AS FOLLOWS:
ENGLISH FT-IN
[METRIC] MM

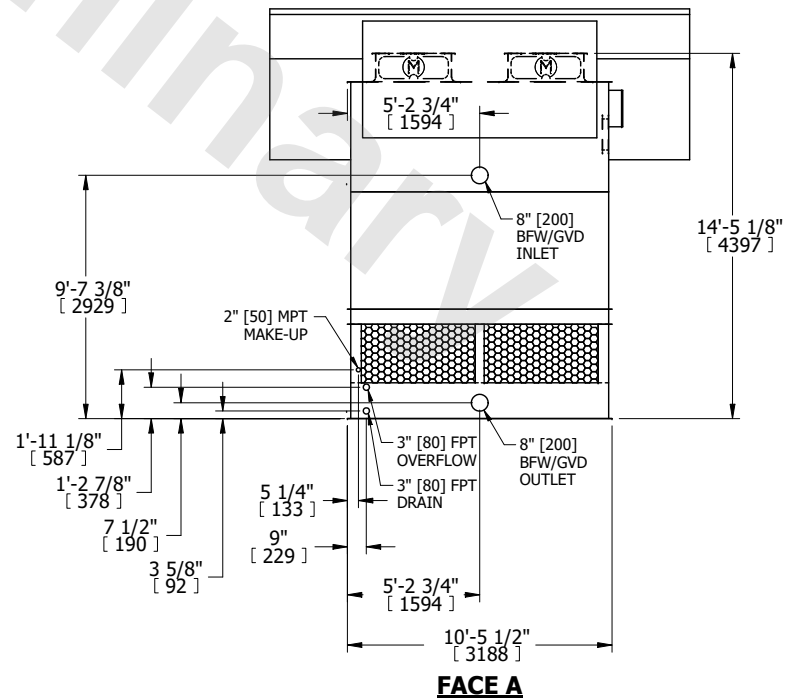
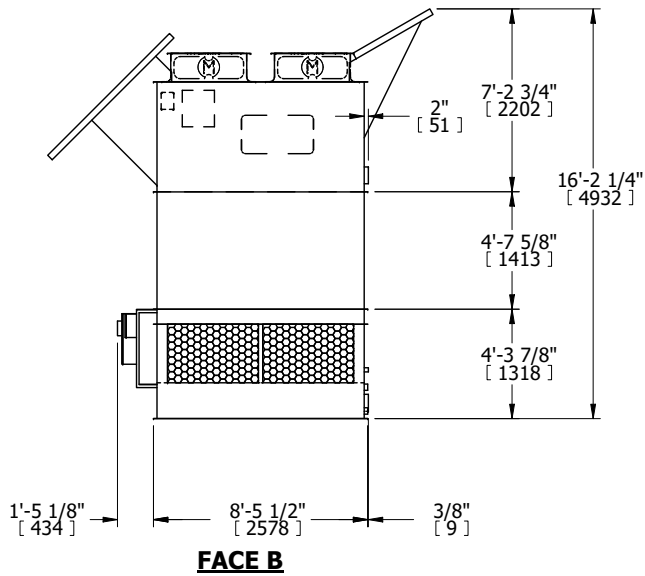
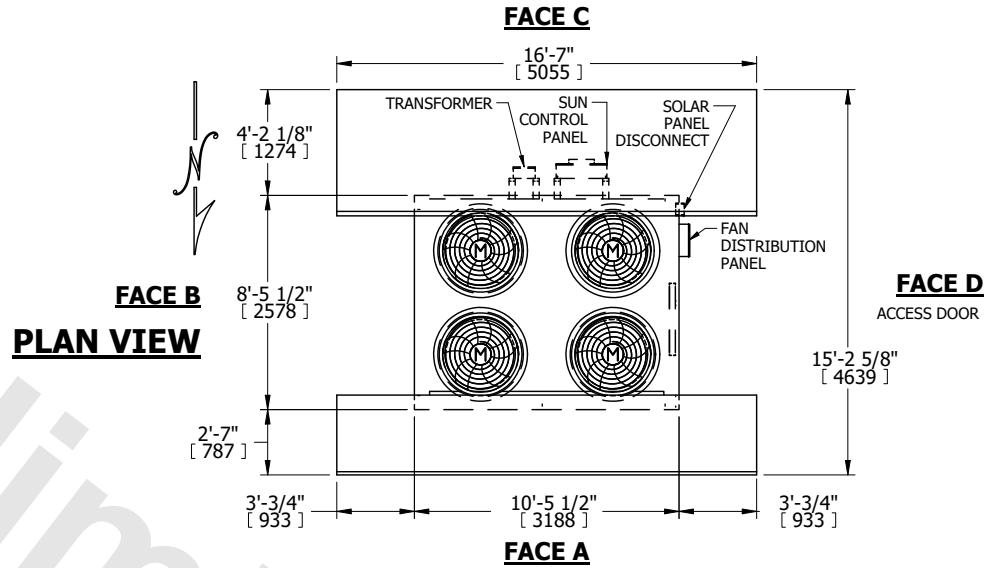

SHIPPING WEIGHT	6000 lbs+ [2725] kg+	OPERATING WEIGHT	9030 lbs+ [4100] kg+	HEAVIEST SECTION WEIGHT	2580 lbs+ [1170] kg+	NO. OF SHIPPING SECTIONS	2	DRAWN BY:	MBG
-----------------	----------------------	------------------	----------------------	-------------------------	----------------------	--------------------------	---	-----------	-----