

# EVAPCO, INC.



UNIT EVAPORATIVE CONDENSER	MODEL # ATC-DC-1024K-25-2EF	SCALE N.T.S.	DWG. # EGCHTM2404-DRA-ST	REV. -	DATE 4/28/2026	SERIAL #
-------------------------------	--------------------------------	-----------------	-----------------------------	-----------	-------------------	----------

- NOTES:
- (M)- FAN MOTOR LOCATION
  - HEAVIEST SECTION IS COIL SECTION
  - MPT DENOTES MALE PIPE THREAD  
FPT DENOTES FEMALE PIPE THREAD  
BFW DENOTES BEVELED FOR WELDING
  - +UNIT WEIGHT DOES NOT INCLUDE ACCESSORIES (SEE ACCESSORY DRAWINGS)
  - MAKE-UP WATER PRESSURE  
20 psi MIN [137 kPa], 50 psi MAX [344 kPa]

- DIMENSIONS LISTED AS FOLLOWS:  
ENGLISH IN  
[METRIC] [mm]
- \* - APPROXIMATE DIMENSIONS DO NOT USE FOR PRE-FABRICATION OF CONNECTING PIPING.

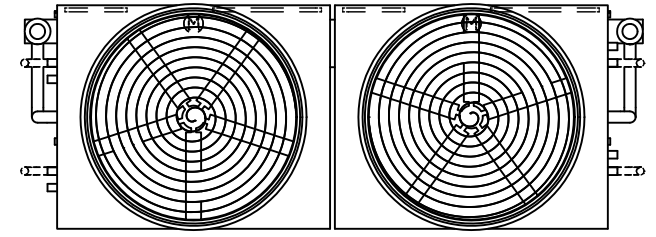

**FACE 2  
PLAN VIEW**

**FACE 1**

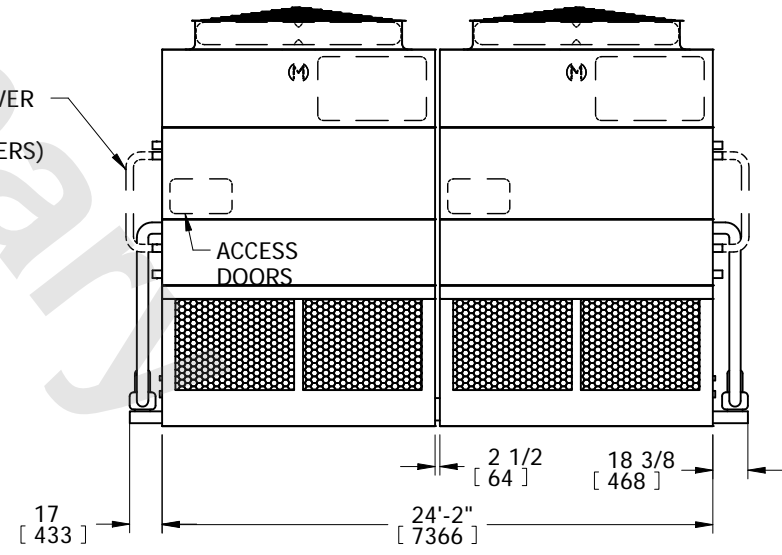
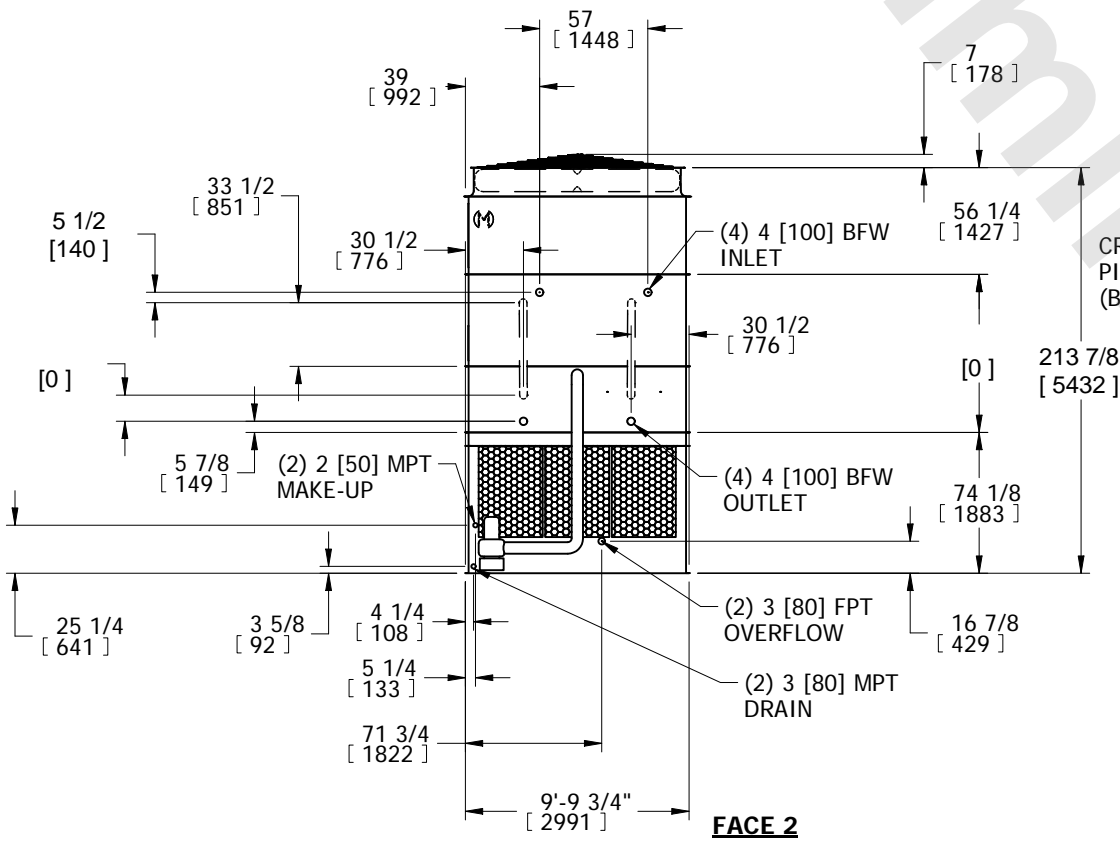

**FACE 1**

SHIPPING WEIGHT 35330 lbs+ [16030] kg+	OPERATING WEIGHT 47900 lbs+ [21730] kg+	HEAVIEST SECTION WEIGHT 14150 lbs+ [6420] kg+	NO. OF SHIPPING SECTIONS 6	DRAWN BY: SFR
---	--	--	-------------------------------	------------------