

EVAPCO, INC.



| | | | | | | |
|-------------------------------|--------------------------------|-----------------|-----------------------------|-----------|-------------------|----------|
| UNIT EVAPORATIVE CONDENSER | MODEL # ATC-DC-1018J-25-2EF | SCALE N.T.S. | DWG. # EGCHTM1804-DRA-ST | REV. - | DATE 6/19/2026 | SERIAL # |
|-------------------------------|--------------------------------|-----------------|-----------------------------|-----------|-------------------|----------|

- NOTES:
- (M)- FAN MOTOR LOCATION
 - HEAVIEST SECTION IS COIL SECTION
 - MPT DENOTES MALE PIPE THREAD
FPT DENOTES FEMALE PIPE THREAD
BFW DENOTES BEVELED FOR WELDING
 - +UNIT WEIGHT DOES NOT INCLUDE ACCESSORIES (SEE ACCESSORY DRAWINGS)
 - MAKE-UP WATER PRESSURE
20 psi MIN [137 kPa], 50 psi MAX [344 kPa]

- DIMENSIONS LISTED AS FOLLOWS:
ENGLISH IN
[METRIC] [mm]
- * - APPROXIMATE DIMENSIONS DO NOT USE FOR PRE-FABRICATION OF CONNECTING PIPING.

**FACE 2
PLAN VIEW**

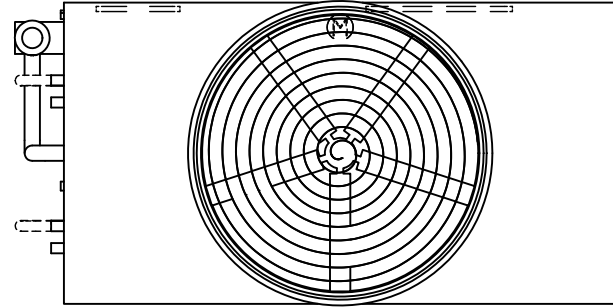

FACE 1

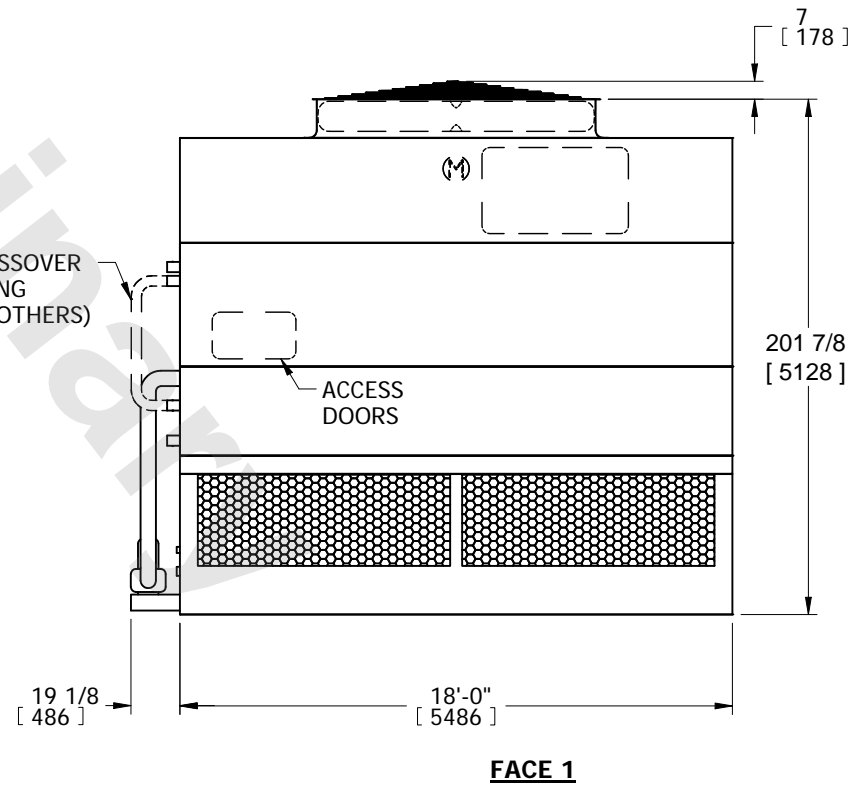
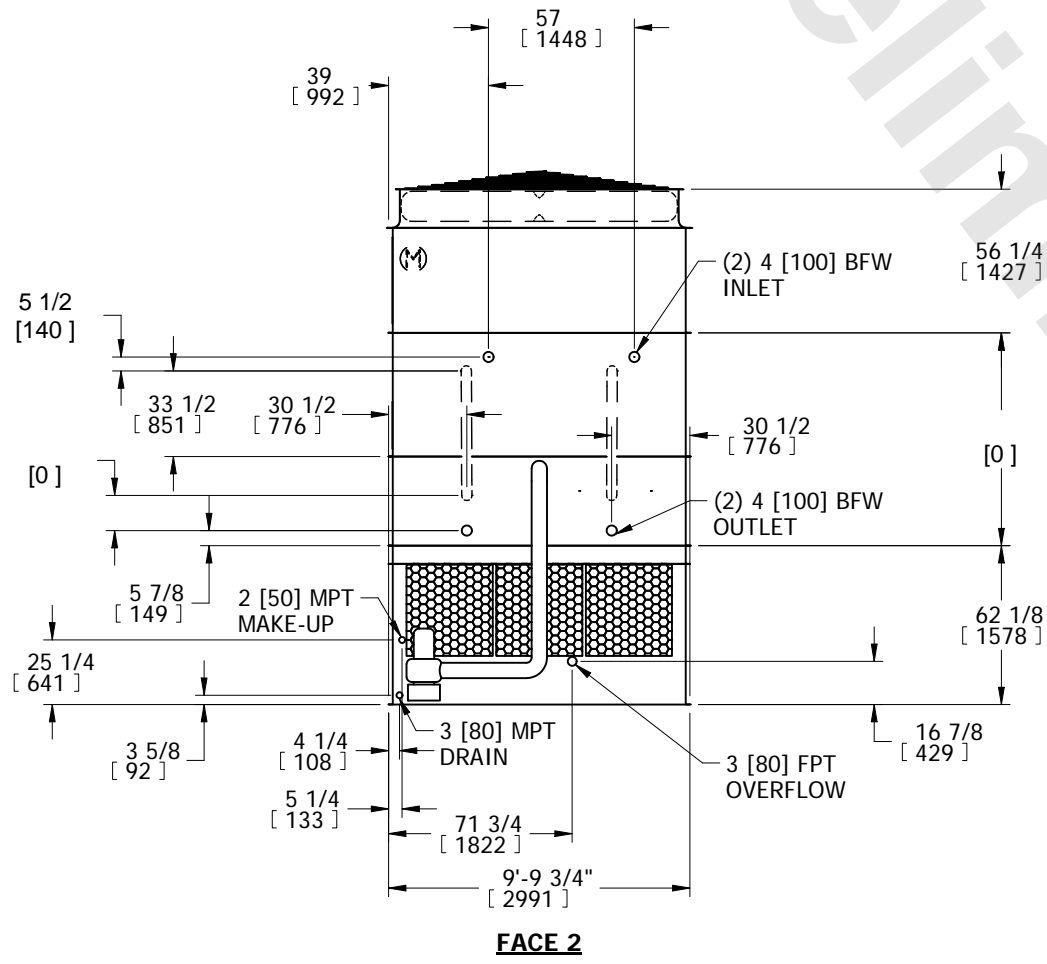

FACE 2

FACE 1

| | | | | |
|---|--|--|-------------------------------|------------------|
| SHIPPING WEIGHT 24970 lbs+ [11330] kg+ | OPERATING WEIGHT 33000 lbs+ [14970] kg+ | HEAVIEST SECTION WEIGHT 18070 lbs+ [8200] kg+ | NO. OF SHIPPING SECTIONS 3 | DRAWN BY: SFR |
|---|--|--|-------------------------------|------------------|