

EVAPCO, INC.



UNIT EVAPORATIVE CONDENSER	MODEL # ATC-DC-1036K-35-1EF	SCALE N.T.S.	DWG. # EGCHTM3602-DRA-ST	REV. -	DATE 4/28/2026	SERIAL #
-------------------------------	--------------------------------	-----------------	-----------------------------	-----------	-------------------	----------

- NOTES:
- (M)- FAN MOTOR LOCATION
 - HEAVIEST SECTION IS COIL SECTION
 - MPT DENOTES MALE PIPE THREAD
FPT DENOTES FEMALE PIPE THREAD
BFW DENOTES BEVELED FOR WELDING
 - +UNIT WEIGHT DOES NOT INCLUDE ACCESSORIES (SEE ACCESSORY DRAWINGS)
 - MAKE-UP WATER PRESSURE
20 psi MIN [137 kPa], 50 psi MAX [344 kPa]

- DIMENSIONS LISTED AS FOLLOWS:
ENGLISH IN
[METRIC] [mm]
- * - APPROXIMATE DIMENSIONS DO NOT USE FOR PRE-FABRICATION OF CONNECTING PIPING.

**FACE 2
PLAN VIEW**



FACE 1

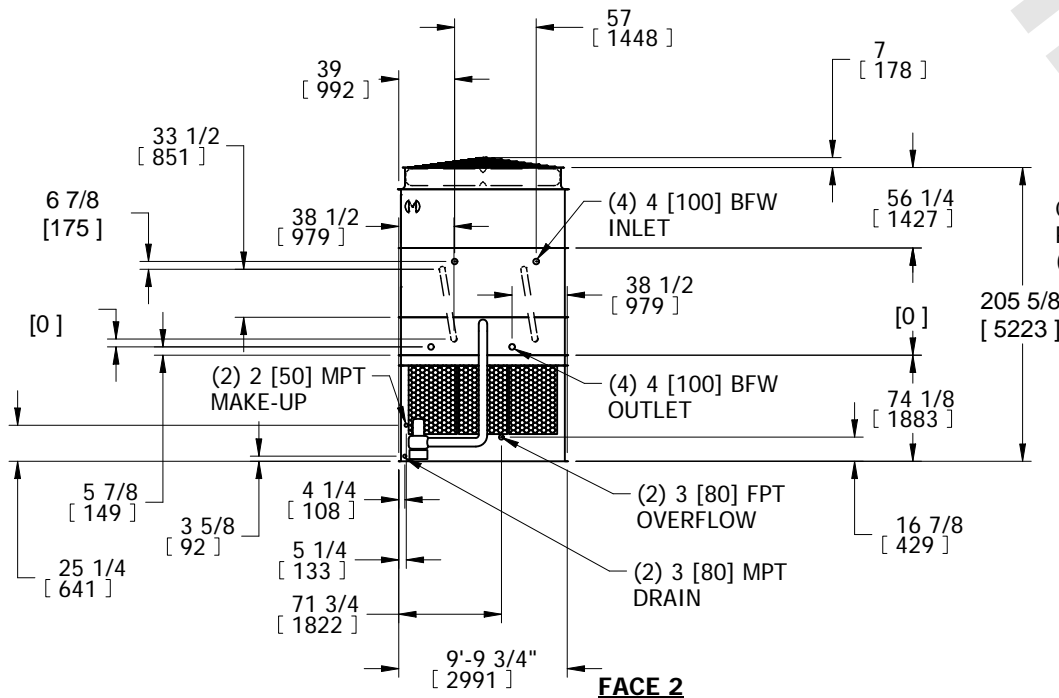

CROSSOVER PIPING (BY OTHERS)

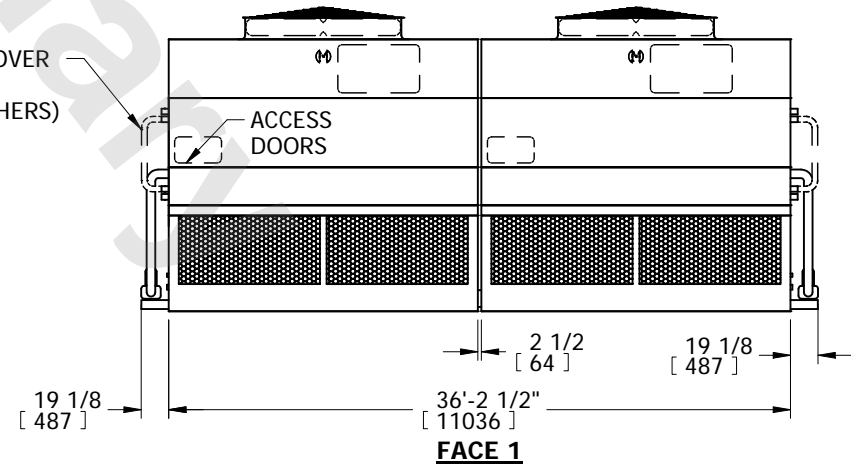

SHIPPING WEIGHT 45670 lbs+ [20720] kg+	OPERATING WEIGHT 64870 lbs+ [29425] kg+	HEAVIEST SECTION WEIGHT 19440 lbs+ [8820] kg+	NO. OF SHIPPING SECTIONS 6	DRAWN BY: SFR
---	--	--	-------------------------------	------------------