

# EVAPCO, INC.



UNIT EVAPORATIVE CONDENSER	MODEL # ATC-DC-1036J-35-1EF	SCALE N.T.S.	DWG. # EGCHTM3602-DRA-ST	REV. -	DATE 6/19/2026	SERIAL #
-------------------------------	--------------------------------	-----------------	-----------------------------	-----------	-------------------	----------

- NOTES:
- (M)- FAN MOTOR LOCATION
  - HEAVIEST SECTION IS COIL SECTION
  - MPT DENOTES MALE PIPE THREAD  
FPT DENOTES FEMALE PIPE THREAD  
BFW DENOTES BEVELED FOR WELDING
  - +UNIT WEIGHT DOES NOT INCLUDE ACCESSORIES (SEE ACCESSORY DRAWINGS)
  - MAKE-UP WATER PRESSURE  
20 psi MIN [137 kPa], 50 psi MAX [344 kPa]

- DIMENSIONS LISTED AS FOLLOWS:  
ENGLISH IN  
[METRIC] [mm]
- \* - APPROXIMATE DIMENSIONS DO NOT USE FOR PRE-FABRICATION OF CONNECTING PIPING.

**FACE 2  
PLAN VIEW**

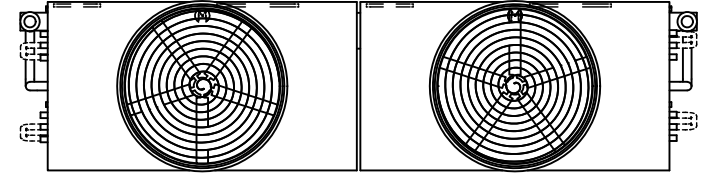

**FACE 1**

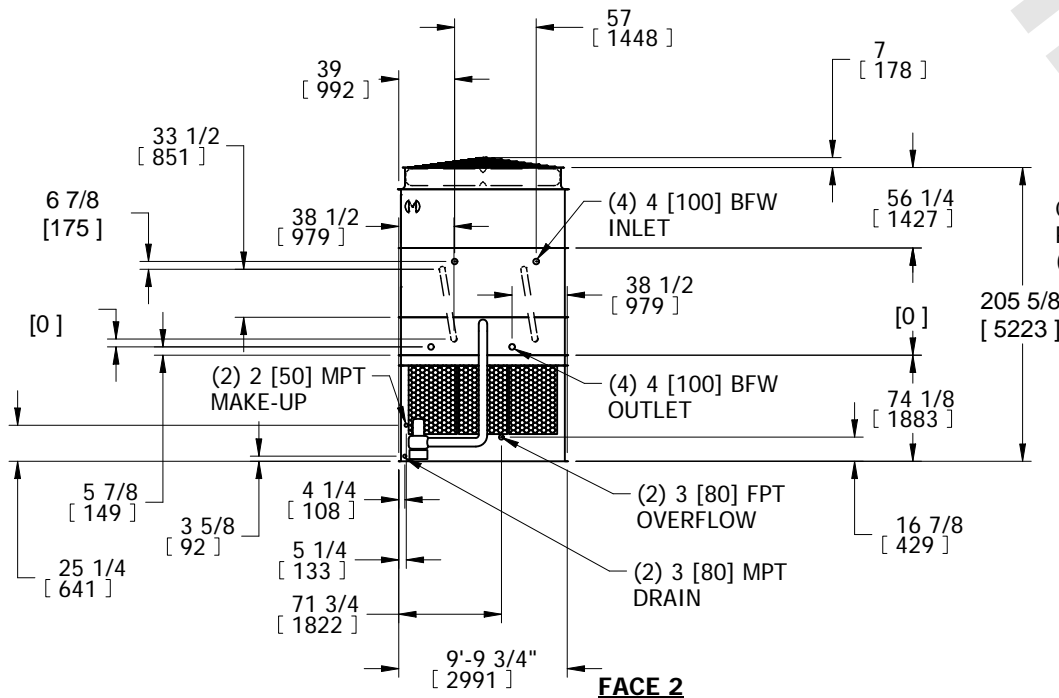

CROSSOVER PIPING (BY OTHERS)

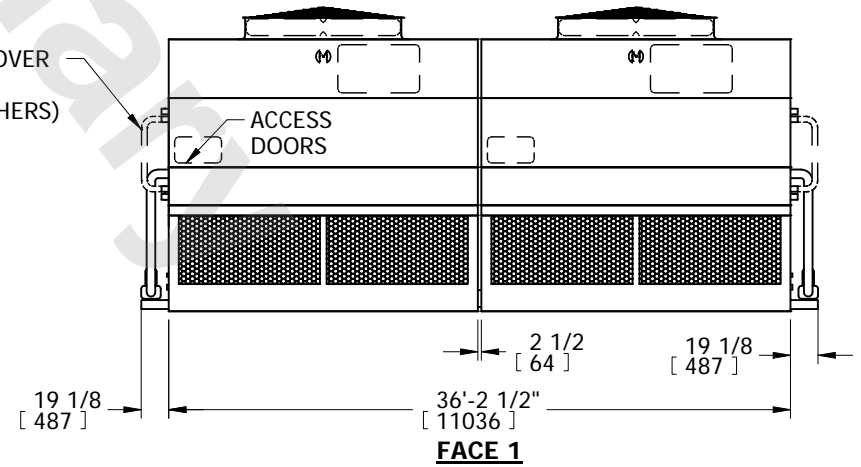

SHIPPING WEIGHT 45550 lbs+ [20665] kg+	OPERATING WEIGHT 64750 lbs+ [29375] kg+	HEAVIEST SECTION WEIGHT 19440 lbs+ [8820] kg+	NO. OF SHIPPING SECTIONS 6	DRAWN BY: SFR
---	--	--	-------------------------------	------------------