

UNIT	CONDENSER	
MODEL #	ATC-2002E	SCALE NTS



DWG. #	WB3242410-DRD-ST	REV.	-
SERIAL #		DATE	7/5/2026

- NOTES:
- (M)- FAN MOTOR LOCATION
 - HEAVIEST SECTION IS UPPER SECTION
 - MPT DENOTES MALE PIPE THREAD
FPT DENOTES FEMALE PIPE THREAD
BFW DENOTES BEVELED FOR WELDING
GVD DENOTES GROOVED
FLG DENOTES FLANGE
PE DENOTES PLAIN END
 - +UNIT WEIGHT DOES NOT INCLUDE ACCESSORIES (SEE ACCESSORY DRAWINGS)
 - MAKE-UP WATER PRESSURE
20 psi MIN [137 kPa], 50 psi MAX [344 kPa]
 - *-APPROXIMATE DIMENSIONS DO NOT USE FOR PRE-FABRICATION OF CONNECTING PIPING
 - 3/4" [19mm] DIA. MOUNTING HOLES. REFER TO RECOMMENDED STEEL SUPPORT DRAWING.
 - DIMENSIONS LISTED AS FOLLOWS:
ENGLISH FT-IN
METRIC [mm]

**FACE B
PLAN VIEW**

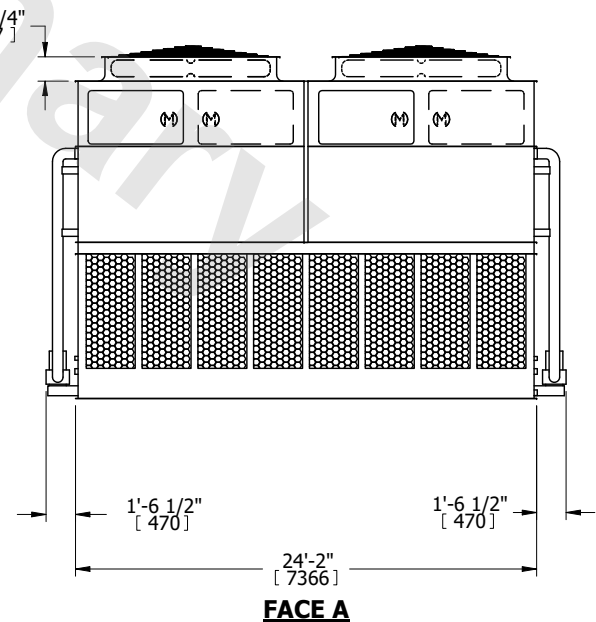

SHIPPING WEIGHT	75540 lbs+ [34265] kg+	OPERATING WEIGHT	103480 lbs+ [46940] kg+	HEAVIEST SECTION WEIGHT	16090 lbs+ [7300] kg+	NO. OF SHIPPING SECTIONS	6	DRAWN BY:	SLR
-----------------	------------------------	------------------	-------------------------	-------------------------	-----------------------	--------------------------	---	-----------	-----