

UNIT	COOLING TOWER	
MODEL #	AT 212-2F9	SCALE NTS

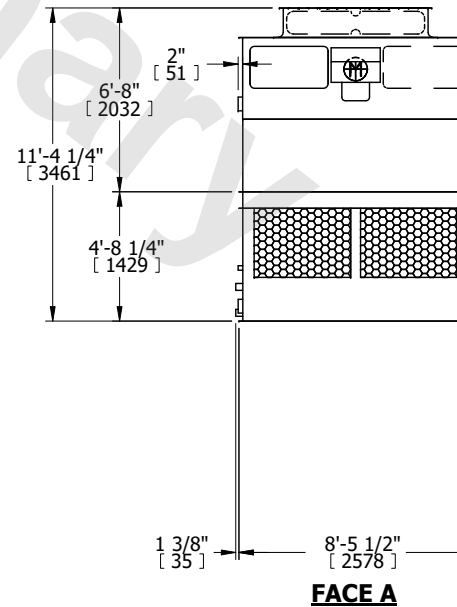

DWG. #	T3128524-DRF-ST	REV.	-
SERIAL #		DATE	7/4/2026

- NOTES:
- (M)- FAN MOTOR LOCATION
 - HEAVIEST SECTION IS UPPER SECTION
 - MPT DENOTES MALE PIPE THREAD
FPT DENOTES FEMALE PIPE THREAD
BFW DENOTES BEVELED FOR WELDING
GVD DENOTES GROOVED
FLG DENOTES FLANGE
 - +UNIT WEIGHT DOES NOT INCLUDE ACCESSORIES (SEE ACCESSORY DRAWINGS)
 - MAKE-UP WATER PRESSURE
20 psi MIN [137 kPa], 50 psi MAX [344 kPa]
 - 3/4" [19MM] DIA. MOUNTING HOLES.
REFER TO RECOMMENDED STEEL SUPPORT DRAWING
 - DIMENSIONS LISTED AS FOLLOWS:
ENGLISH FT-IN
[METRIC] [mm]

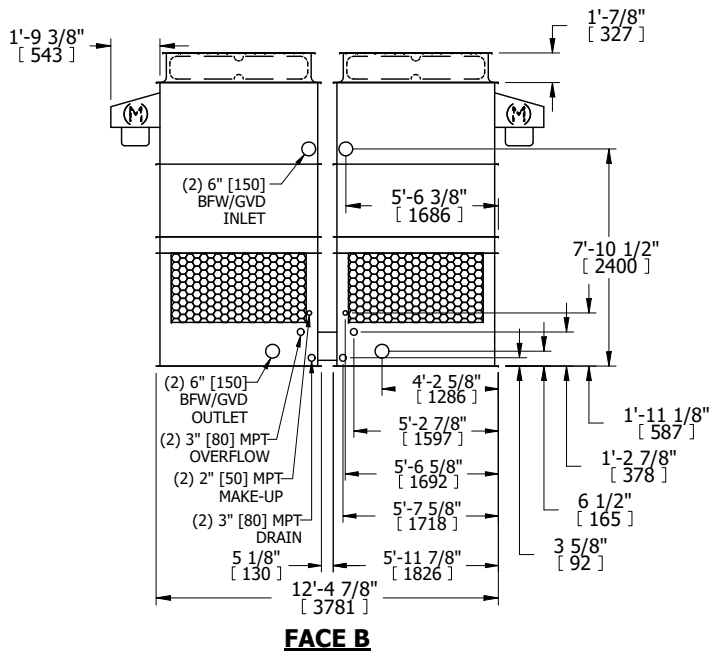
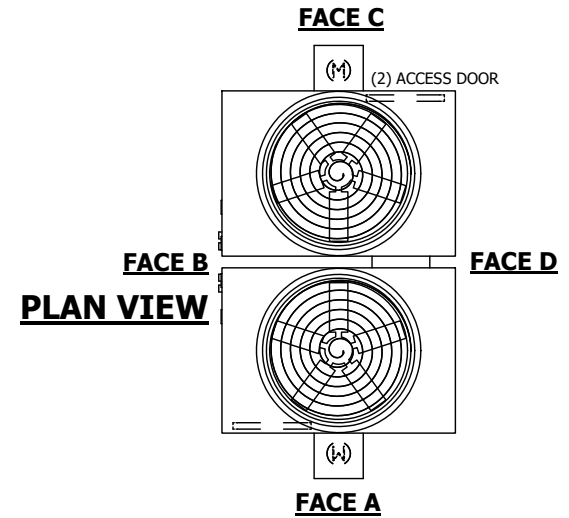

SHIPPING WEIGHT	6360 lbs+ [2885] kg+	OPERATING WEIGHT	10440 lbs+ [4740] kg+	HEAVIEST SECTION WEIGHT	1990 lbs+ [905] kg+	NO. OF SHIPPING SECTIONS	4	DRAWN BY:	KDS
-----------------	----------------------	------------------	-----------------------	-------------------------	---------------------	--------------------------	---	-----------	-----