

UNIT	COOLING TOWER	
MODEL #	AT 214-5O52	SCALE NTS

EVAPCO, INC.

DWG. #	T4145260-DRA-ST	REV.	-
SERIAL #		DATE	5/7/2026

- NOTES:
- (M)- FAN MOTOR LOCATION
 - HEAVIEST SECTION IS UPPER SECTION
 - MPT DENOTES MALE PIPE THREAD
FPT DENOTES FEMALE PIPE THREAD
BFW DENOTES BEVELED FOR WELDING
GVD DENOTES GROOVED
FLG DENOTES FLANGE
PE DENOTES PLAIN END
 - +UNIT WEIGHT DOES NOT INCLUDE ACCESSORIES (SEE ACCESSORY DRAWINGS)
 - MAKE-UP WATER PRESSURE
20 psi MIN [137 kPa], 50 psi MAX [344 kPa]
 - 3/4" [19MM] DIA. MOUNTING HOLES. REFER TO RECOMMENDED STEEL SUPPORT DRAWING
 - DIMENSIONS LISTED AS FOLLOWS:
ENGLISH FT-IN
[METRIC] [mm]

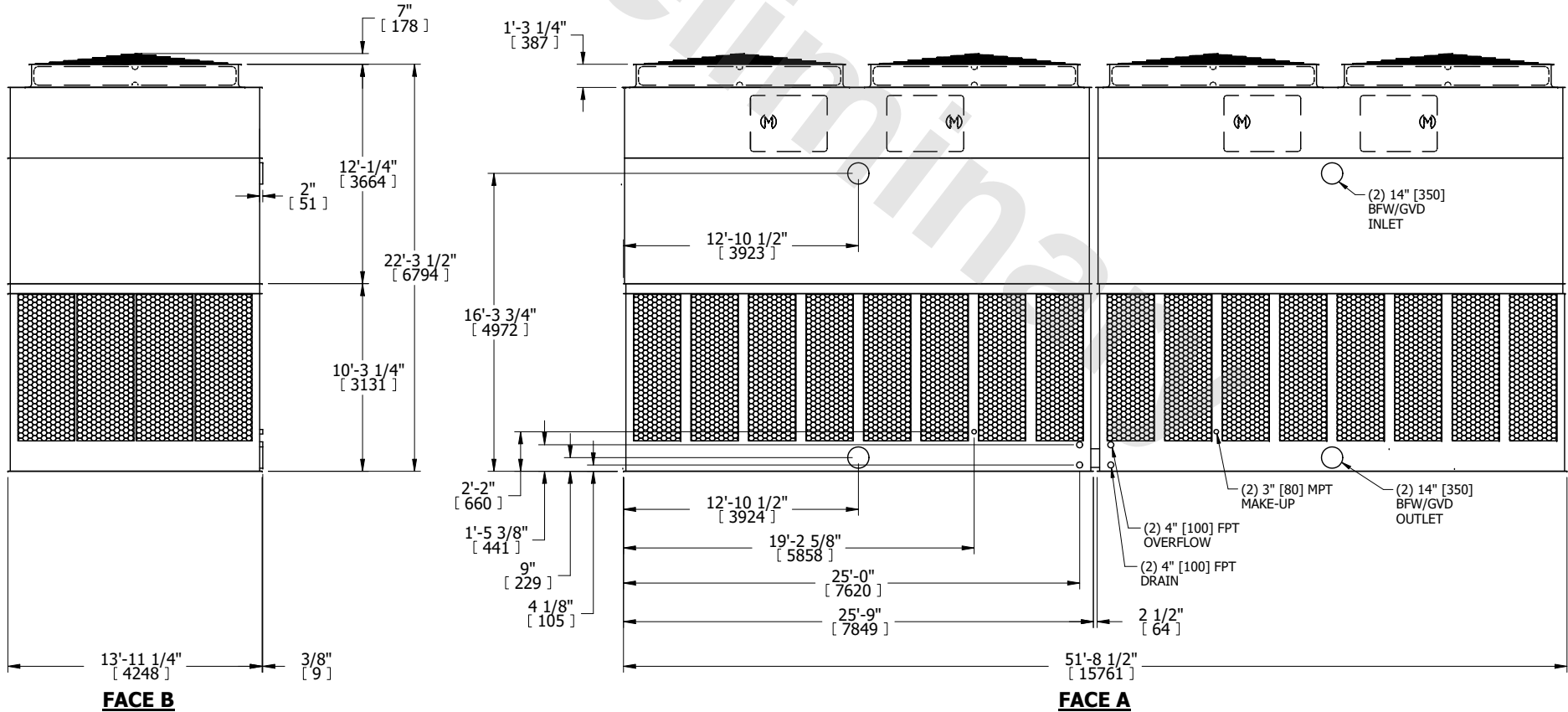

SHIPPING WEIGHT	50200 lbs+ [22775] kg+	OPERATING WEIGHT	83500 lbs+ [37875] kg+	HEAVIEST SECTION WEIGHT	18160 lbs+ [8240] kg+	NO. OF SHIPPING SECTIONS	4	DRAWN BY:	MER
-----------------	------------------------	------------------	------------------------	-------------------------	-----------------------	--------------------------	---	-----------	-----