

UNIT	CLOSED CIRCUIT COOLER	
MODEL #	ATWB 24-5P20	SCALE NTS



DWG. #	WB3242010-DRC-ST	REV.	-
SERIAL #		DATE	6/26/2026

- NOTES:
- (M)- FAN MOTOR LOCATION
 - HEAVIEST SECTION IS UPPER SECTION
 - MPT DENOTES MALE PIPE THREAD
FPT DENOTES FEMALE PIPE THREAD
BFW DENOTES BEVELED FOR WELDING
GVD DENOTES GROOVED
FLG DENOTES FLANGE
PE DENOTES PLAIN END
 - +UNIT WEIGHT DOES NOT INCLUDE ACCESSORIES (SEE ACCESSORY DRAWINGS)
 - MAKE-UP WATER PRESSURE
20 psi MIN [137 kPa], 50 psi MAX [344 kPa]
 - *-APPROXIMATE DIMENSIONS DO NOT USE FOR PRE-FABRICATION OF CONNECTING PIPING
 - 3/4" [19mm] DIA. MOUNTING HOLES. REFER TO RECOMMENDED STEEL SUPPORT DRAWING.
 - DIMENSIONS LISTED AS FOLLOWS:
ENGLISH FT-IN
METRIC [mm]

**FACE B
PLAN VIEW**

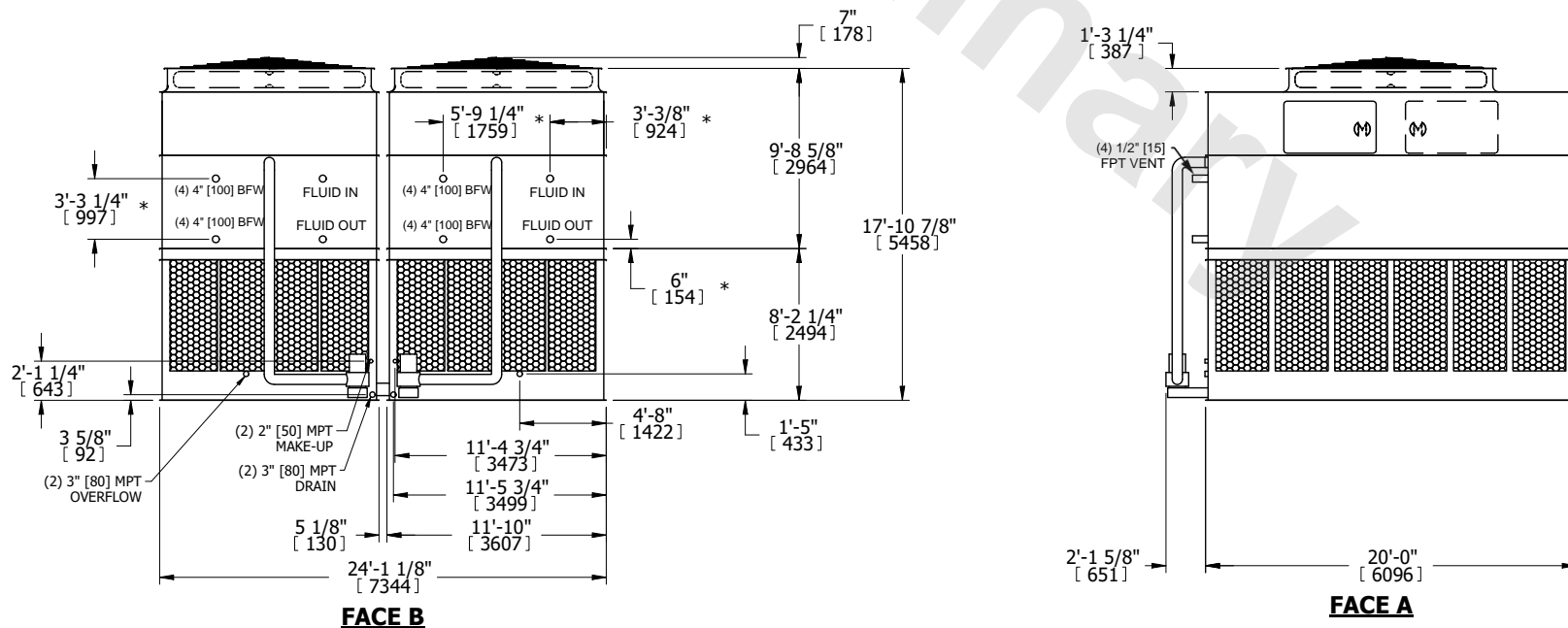

SHIPPING WEIGHT	60480 lbs+ [27435] kg+	OPERATING WEIGHT	94900 lbs+ [43050] kg+	HEAVIEST SECTION WEIGHT	25730 lbs+ [11675] kg+	NO. OF SHIPPING SECTIONS	4	DRAWN BY:	SLR
-----------------	------------------------	------------------	------------------------	-------------------------	------------------------	--------------------------	---	-----------	-----