

UNIT	CLOSED CIRCUIT COOLER	
MODEL #	ATWB 14-5J14-Z	SCALE NTS

EVAPCO, INC.

DWG. #	CW4C141410-DRB-ST	REV	-
SERIAL #		DATE:	6/27/2026

NOTES

1. (M)- FAN MOTOR LOCATION
2. HEAVIEST SECTION IS FAN/CASING SECTION
3. MPT DENOTES MALE PIPE THREAD
 FPT DENOTES FEMALE PIPE THREAD
 BFW DENOTES BEVELED FOR WELDING
 GVD DENOTES GROOVED
 FLG DENOTES FLANGE
 PE DENOTES PLAIN END
4. +UNIT WEIGHT DOES NOT INCLUDE ACCESSORIES (SEE ACCESSORY DRAWINGS)
5. MAKE-UP WATER PRESSURE
 20 psi MIN [137 kPa], 50 psi MAX [344 kPa]
6. *-APPROXIMATE DIMENSIONS DO NOT USE FOR PRE-FABRICATION OF CONNECTING PIPING
7. 3/4" [19mm] DIA. MOUNTING HOLES. REFER TO RECOMMENDED STEEL SUPPORT DRAWING.
8. DIMENSIONS LISTED AS FOLLOWS:
 ENGLISH FT-IN
 METRIC [mm]

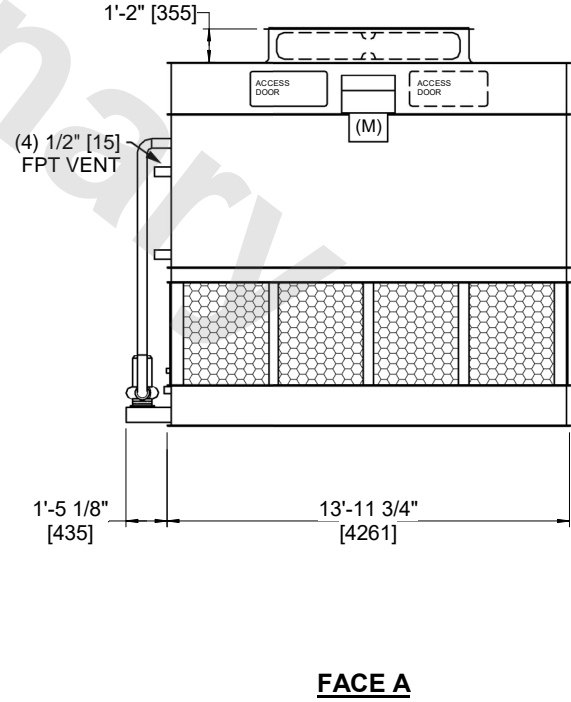
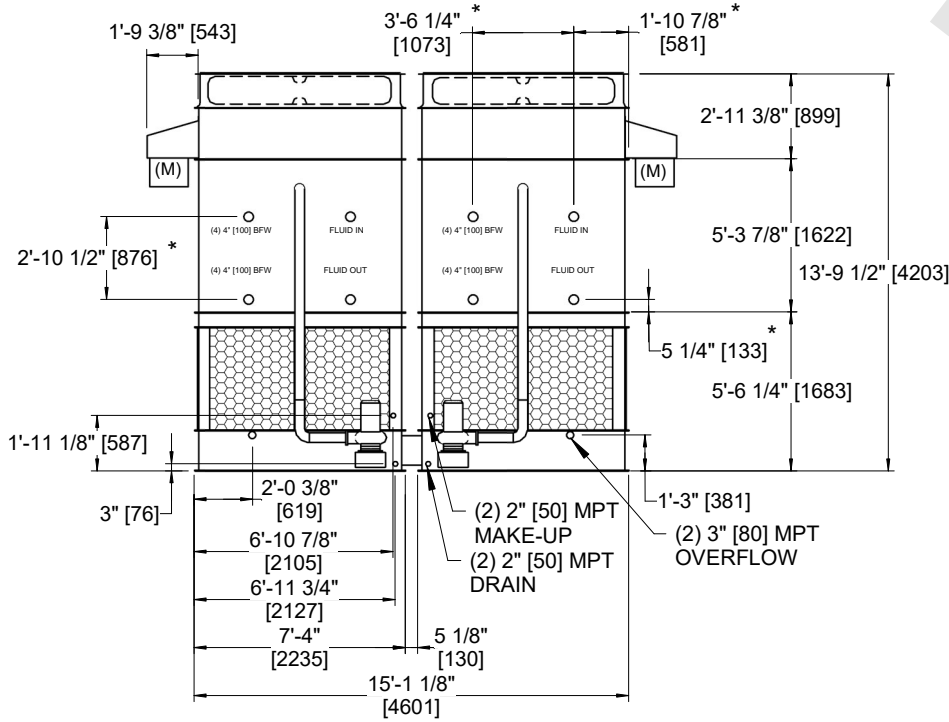
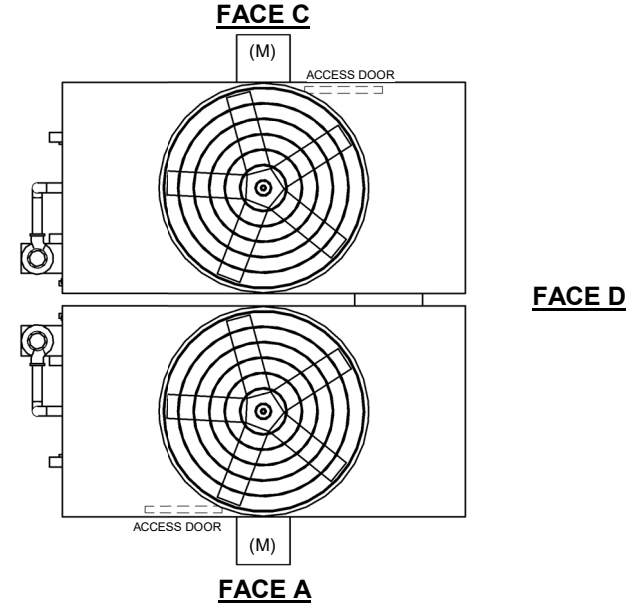

SHIPPING WEIGHT	27680 lbs+ [12560] kg+	OPERATING WEIGHT	37980 lbs+ [17230] kg+	HEAVIEST SECTION WEIGHT	11650 lbs+ [5285] kg+	NO. OF SHIPPING SECTIONS	4	DRAWN BY:	JLG
-----------------	------------------------	------------------	------------------------	-------------------------	-----------------------	--------------------------	---	-----------	-----