

UNIT	CLOSED CIRCUIT COOLER	
MODEL #	LRWB 3-2D6-Z	SCALE NTS

EVAPCO, INC.

DWG. #	WV030604-DRD-SF	REV.	-
SERIAL #		DATE	6/23/2026

- NOTES:
- (M)- FAN MOTOR LOCATION
 - MPT DENOTES MALE PIPE THREAD
FPT DENOTES FEMALE PIPE THREAD
BFW DENOTES BEVELED FOR WELDING
GVD DENOTES GROOVED
FLG DENOTES FLANGE
PE DENOTES PLAIN END
 - +UNIT WEIGHT DOES NOT INCLUDE ACCESSORIES (SEE ACCESSORY DRAWINGS)
 - 3/4" [19mm] DIA. MOUNTING HOLES. REFER TO RECOMMENDED STEEL SUPPORT DRAWING
 - DIMENSIONS LISTED AS FOLLOWS: ENGLISH FT IN [METRIC] [mm]
 - * - APPROXIMATE DIMENSIONS DO NOT USE FOR PRE-FABRICATION OF CONNECTING PIPING.
 - MAKE-UP WATER PRESSURE
20 psi [137 kPa] MIN, 50 psi [344 kPa] MAX
 - SERIES FLOW PIPING AND AUX. CROSSOVER DRAIN ARE BY OTHERS

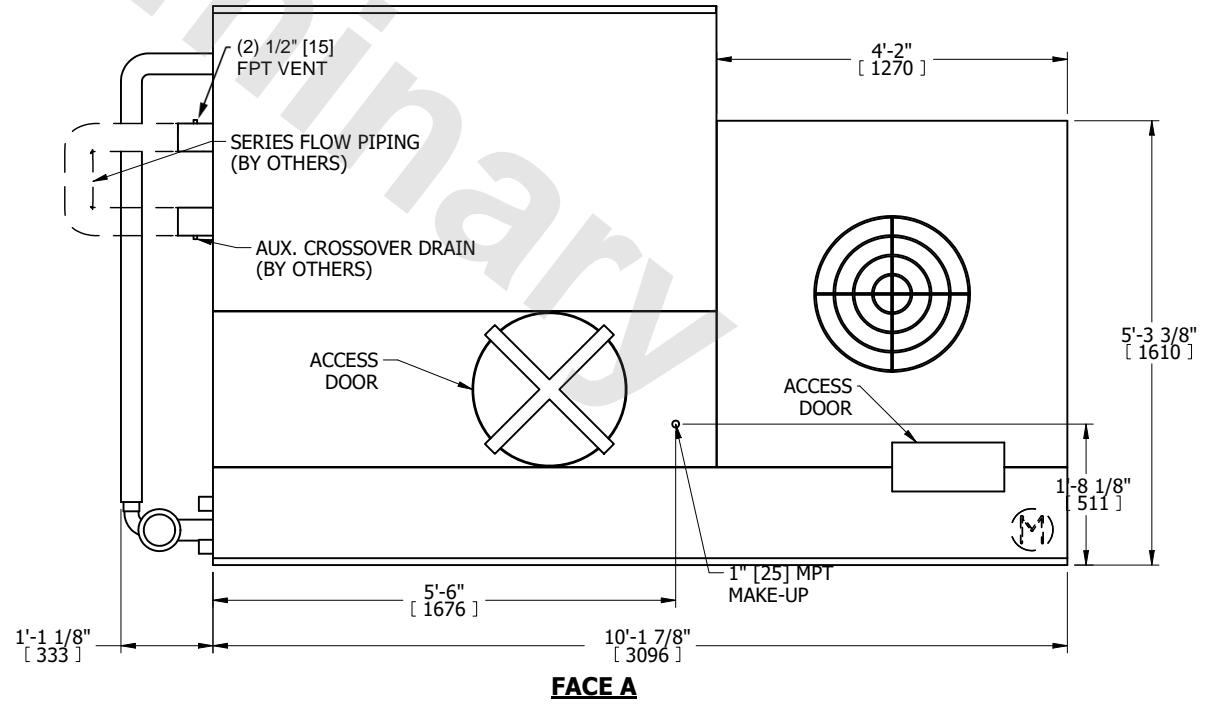
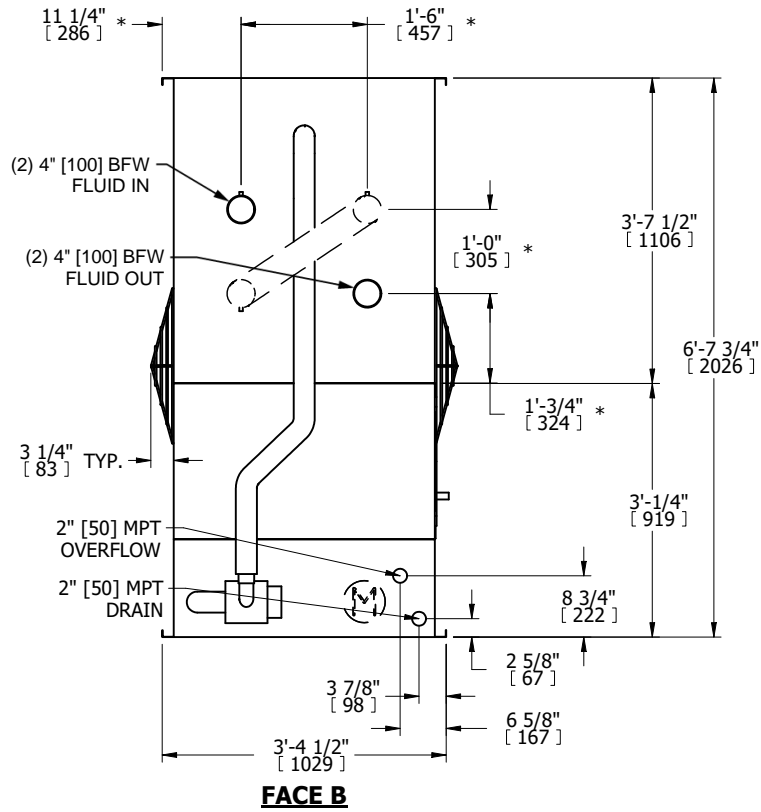

SHIPPING WEIGHT	2170 lbs+ [985] kg+	OPERATING WEIGHT	3400 lbs+ [1545] kg+	HEAVIEST SECTION WEIGHT	2170 lbs+ [985] kg+	NO. OF SHIPPING SECTIONS	1	DRAWN BY:	
-----------------	---------------------	------------------	----------------------	-------------------------	---------------------	--------------------------	---	-----------	--