

|         |                       |           |
|---------|-----------------------|-----------|
| UNIT    | CLOSED CIRCUIT COOLER |           |
| MODEL # | LRWB 5-6L12-Z         | SCALE NTS |

# EVAPCO, INC.

|          |                 |      |           |
|----------|-----------------|------|-----------|
| DWG. #   | WV051212-DRD-SF | REV. | -         |
| SERIAL # |                 | DATE | 5/10/2026 |

- NOTES:
- (M)- FAN MOTOR LOCATION
  - MPT DENOTES MALE PIPE THREAD  
FPT DENOTES FEMALE PIPE THREAD  
BFW DENOTES BEVELED FOR WELDING  
GVD DENOTES GROOVED  
FLG DENOTES FLANGE  
PE DENOTES PLAIN END
  - +UNIT WEIGHT DOES NOT INCLUDE ACCESSORIES (SEE ACCESSORY DRAWINGS)
  - 3/4" [19mm] DIA. MOUNTING HOLES. REFER TO RECOMMENDED STEEL SUPPORT DRAWING
  - DIMENSIONS LISTED AS FOLLOWS: ENGLISH FT IN [METRIC] [mm]
  - \* - APPROXIMATE DIMENSIONS DO NOT USE FOR PRE-FABRICATION OF CONNECTING PIPING.
  - MAKE-UP WATER PRESSURE  
20 psi [137 kPa] MIN, 50 psi [344 kPa] MAX
  - SERIES FLOW PIPING AND AUX. CROSSOVER DRAIN ARE BY OTHERS

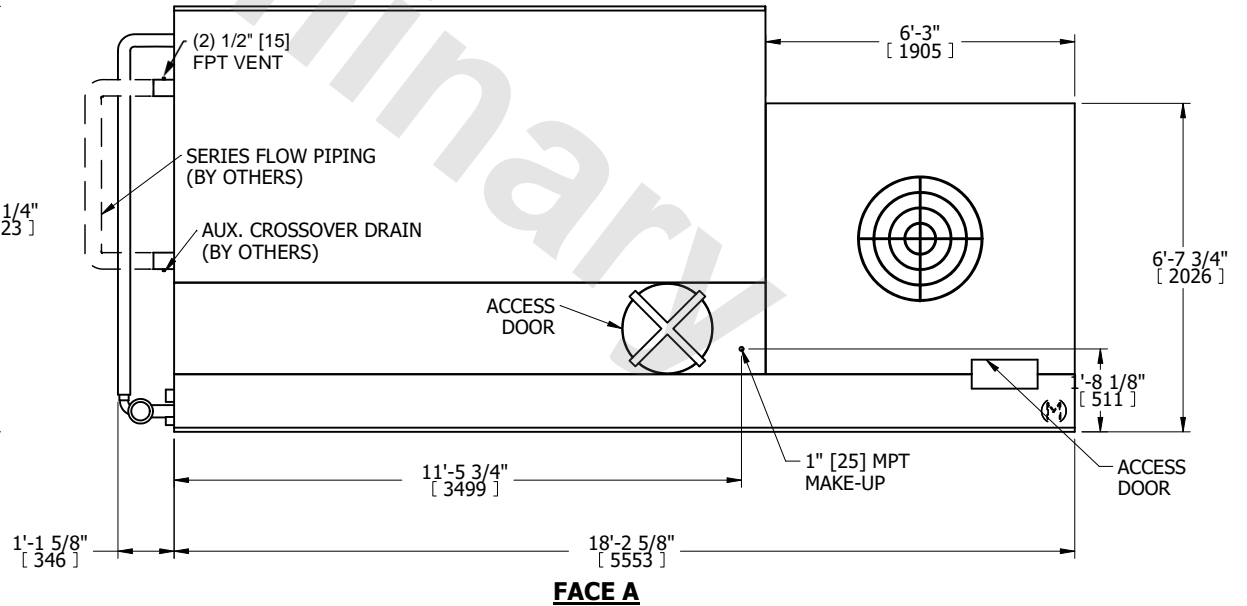
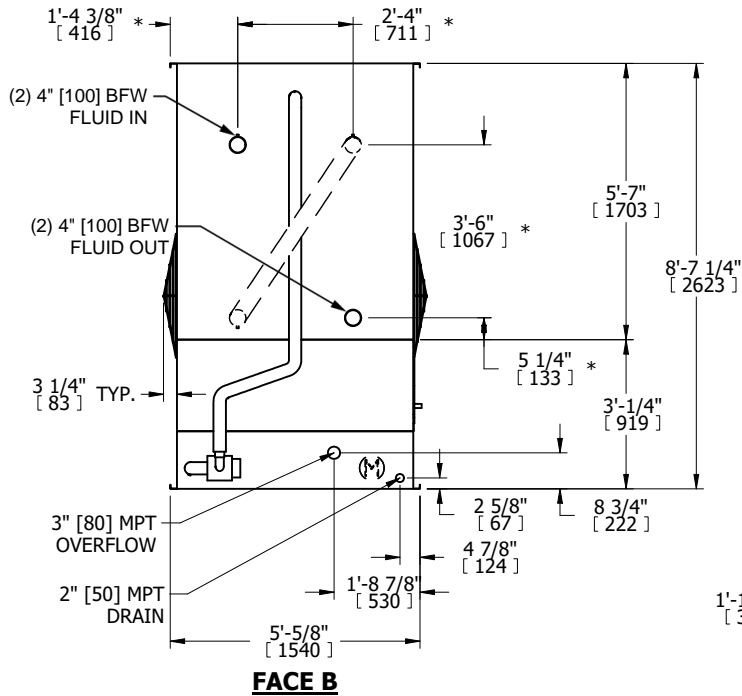

|                 |                      |                  |                       |                         |                      |                          |   |           |  |
|-----------------|----------------------|------------------|-----------------------|-------------------------|----------------------|--------------------------|---|-----------|--|
| SHIPPING WEIGHT | 8880 lbs+ [4030] kg+ | OPERATING WEIGHT | 14440 lbs+ [6550] kg+ | HEAVIEST SECTION WEIGHT | 8880 lbs+ [4030] kg+ | NO. OF SHIPPING SECTIONS | 1 | DRAWN BY: |  |
|-----------------|----------------------|------------------|-----------------------|-------------------------|----------------------|--------------------------|---|-----------|--|