

| | | |
|---------|-----------------------|-----------|
| UNIT | CLOSED CIRCUIT COOLER | |
| MODEL # | LSWE 4-3G9-Z | SCALE NTS |

EVAPCO, INC.

| | | | |
|----------|------------------|------|----------|
| DWG. # | WLE040906-DRD-SF | REV. | - |
| SERIAL # | | DATE | 4/4/2026 |

- NOTES:
- (M)- FAN MOTOR LOCATION
 - MPT DENOTES MALE PIPE THREAD
FPT DENOTES FEMALE PIPE THREAD
BFW DENOTES BEVELED FOR WELDING
GVD DENOTES GROOVED
FLG DENOTES FLANGE
PE DENOTES PLAIN END
 - +UNIT WEIGHT DOES NOT INCLUDE ACCESSORIES (SEE ACCESSORY DRAWINGS)
 - 3/4" [19mm] DIA. MOUNTING HOLES. REFER TO RECOMMENDED STEEL SUPPORT DRAWING
 - DIMENSIONS LISTED AS FOLLOWS: ENGLISH FT IN [METRIC] [mm]
 - * - APPROXIMATE DIMENSIONS DO NOT USE FOR PRE-FABRICATION OF CONNECTING PIPING
 - HEAVIEST SECTION IS COIL SECTION
 - MAKE-UP WATER PRESSURE
20 psi [137 kPa] MIN, 50 psi [344 kPa] MAX
 - MAKE-UP CONNECTION LOCATED 7-5/8" [194] FROM CONNECTION END OF UNIT
 - SERIES FLOW PIPING AND AUX. CROSSOVER DRAIN ARE BY OTHERS

FACE B
PLAN VIEW

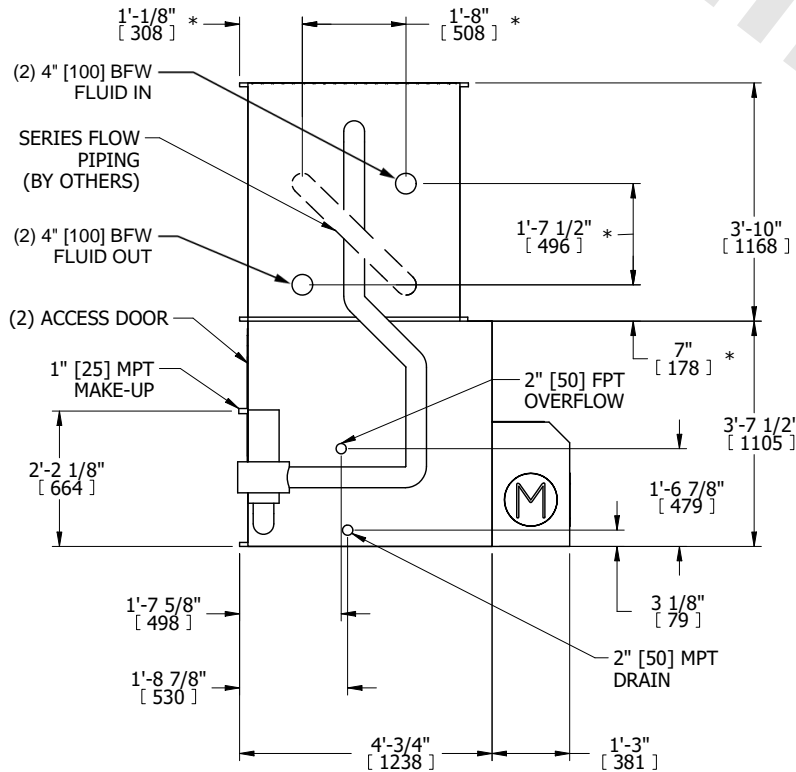

FACE B

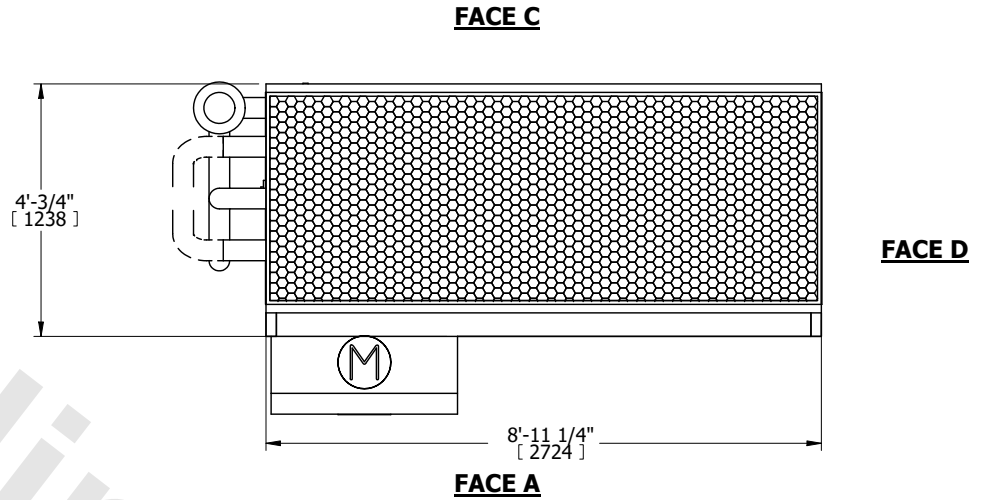

FACE A

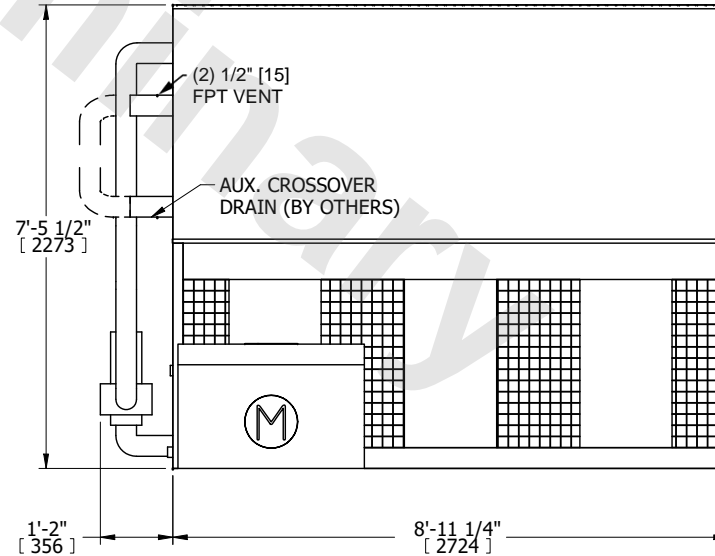

FACE A

| | | | | | | | | | |
|-----------------|----------------------|------------------|----------------------|-------------------------|----------------------|--------------------------|---|-----------|-----|
| SHIPPING WEIGHT | 3750 lbs+ [1705] kg+ | OPERATING WEIGHT | 5330 lbs+ [2420] kg+ | HEAVIEST SECTION WEIGHT | 2260 lbs+ [1030] kg+ | NO. OF SHIPPING SECTIONS | 2 | DRAWN BY: | TLS |
|-----------------|----------------------|------------------|----------------------|-------------------------|----------------------|--------------------------|---|-----------|-----|