

UNIT	CLOSED CIRCUIT COOLER	
MODEL #	eco-ATWB 9-5K9	SCALE NTS

EVAPCO, INC.

DWG. #	WB3090910-DRC-ST	REV.	-
SERIAL #		DATE	7/5/2026

- NOTES:
- (M)- FAN MOTOR LOCATION
 - HEAVIEST SECTION IS UPPER SECTION
 - MPT DENOTES MALE PIPE THREAD
FPT DENOTES FEMALE PIPE THREAD
BFW DENOTES BEVELED FOR WELDING
GVD DENOTES GROOVED
FLG DENOTES FLANGE
PE DENOTES PLAIN END
 - +UNIT WEIGHT DOES NOT INCLUDE ACCESSORIES (SEE ACCESSORY DRAWINGS)
 - MAKE-UP WATER PRESSURE
20 psi MIN [137 kPa], 50 psi MAX [344 kPa]
 - *-APPROXIMATE DIMENSIONS DO NOT USE FOR PRE-FABRICATION OF CONNECTING PIPING
 - 3/4" [19mm] DIA. MOUNTING HOLES. REFER TO RECOMMENDED STEEL SUPPORT DRAWING.
 - DIMENSIONS LISTED AS FOLLOWS:
ENGLISH FT-IN
METRIC [mm]

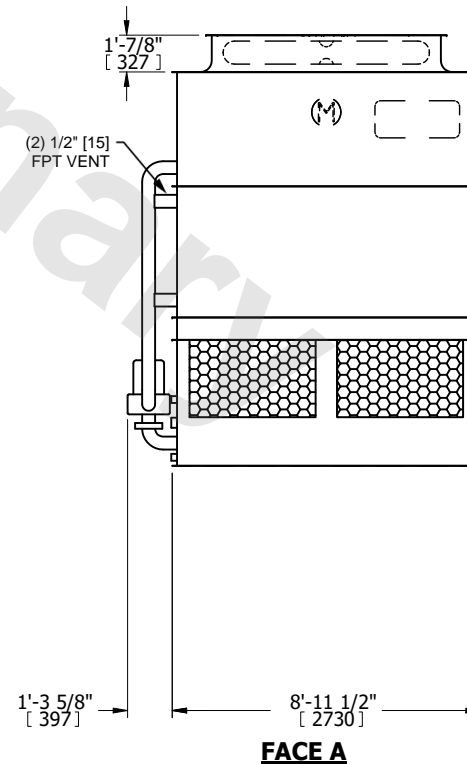
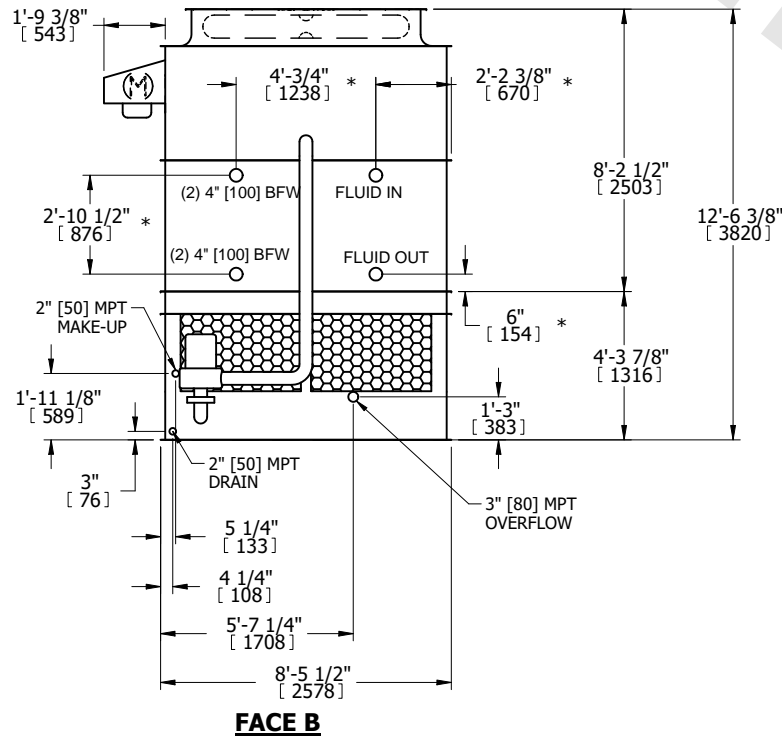

SHIPPING WEIGHT	12990 lbs+ [5895] kg+	OPERATING WEIGHT	17810 lbs+ [8080] kg+	HEAVIEST SECTION WEIGHT	11550 lbs+ [5240] kg+	NO. OF SHIPPING SECTIONS	2	DRAWN BY:	SLR
-----------------	-----------------------	------------------	-----------------------	-------------------------	-----------------------	--------------------------	---	-----------	-----