

UNIT	CLOSED CIRCUIT COOLER	
MODEL #	eco-ATWB 3-4D3-Z	SCALE NTS

# EVAPCO, INC.

DWG. #	WB3030308-DRE-SF	REV.	-
SERIAL #		DATE	11/21/2025

**NOTES:**

- (M)- FAN MOTOR LOCATION
- HEAVIEST SECTION IS UPPER SECTION
- MPT DENOTES MALE PIPE THREAD  
FPT DENOTES FEMALE PIPE THREAD  
BFW DENOTES BEVELED FOR WELDING  
GVD DENOTES GROOVED  
FLG DENOTES FLANGE  
PE DENOTES PLAIN END
- +UNIT WEIGHT DOES NOT INCLUDE ACCESSORIES (SEE ACCESSORY DRAWINGS)
- MAKE-UP WATER PRESSURE  
20 psi MIN [137 kPa], 50 psi MAX [344 kPa]
- \*-APPROXIMATE DIMENSIONS DO NOT USE FOR PRE-FABRICATION OF CONNECTING PIPING
- SERIES FLOW PIPING AND AUX. CROSSOVER DRAIN BY OTHERS.
- 3/4" [19MM] DIA. MOUNTING HOLES. REFER TO RECOMMENDED STEEL SUPPORT DRAWING.
- DIMENSIONS LISTED AS FOLLOWS:  
ENGLISH FT-IN  
[METRIC] MM

**FACE B  
PLAN VIEW**

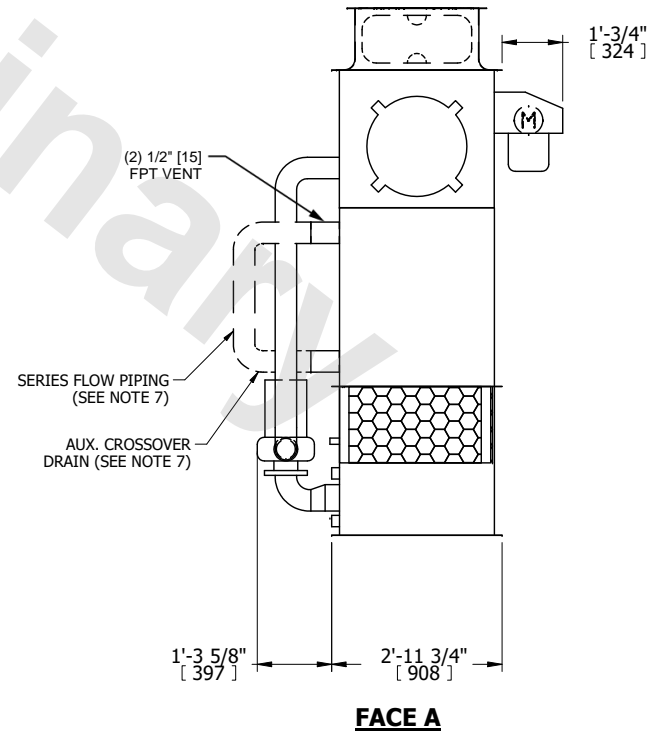
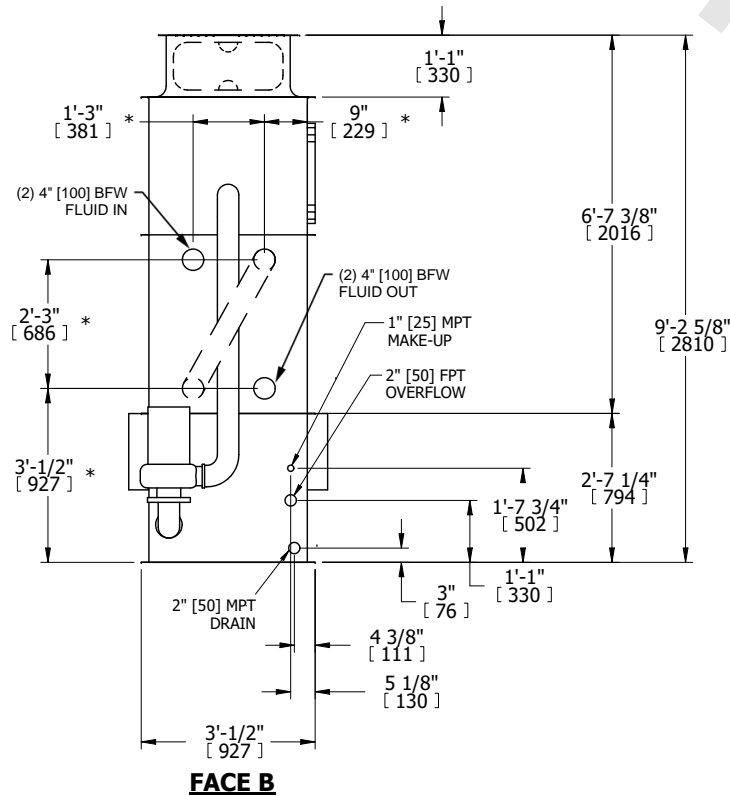
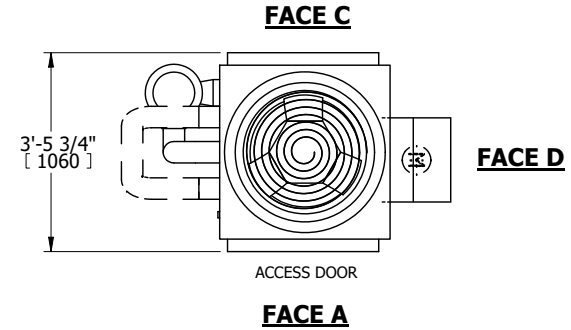

SHIPPING WEIGHT	1670 lbs+ [760] kg+	OPERATING WEIGHT	2290 lbs+ [1040] kg+	HEAVIEST SECTION WEIGHT	1390 lbs+ [635] kg+	NO. OF SHIPPING SECTIONS	2	DRAWN BY:	CAF
-----------------	---------------------	------------------	----------------------	-------------------------	---------------------	--------------------------	---	-----------	-----