

UNIT	<b>CLOSED CIRCUIT COOLER</b>	
MODEL #	eco-ATWB 9-4L14-Z	SCALE NTS

# EVAPCO, INC.

DWG. #	WB3091408-DRC-SF	REV.	-
SERIAL #		DATE	7/5/2026

**NOTES:**

- (M) - FAN MOTOR LOCATION
- HEAVIEST SECTION IS UPPER SECTION
- MPT DENOTES MALE PIPE THREAD  
FPT DENOTES FEMALE PIPE THREAD  
BFW DENOTES BEVELED FOR WELDING  
GVD DENOTES GROOVED  
FLG DENOTES FLANGE  
PE DENOTES PLAIN END
- + UNIT WEIGHT DOES NOT INCLUDE ACCESSORIES (SEE SEPARATE DRAWINGS FOR ACCESSORIES)
- MAKE-UP WATER PRESSURE  
20 psi MIN [137 kPa], 50 psi MAX [344 kPa]
- \* - APPROXIMATE DIMENSIONS DO NOT USE FOR PRE-FABRICATION OF CONNECTING PIPING
- SERIES FLOW PIPING AND AUX. CROSSOVER DRAIN BY OTHERS
- 3/4" [19MM] DIA. MOUNTING HOLES. REFER TO RECOMMENDED STEEL SUPPORT DRAWING.
- DIMENSIONS LISTED AS FOLLOWS:  
ENGLISH FT-IN  
METRIC [mm]

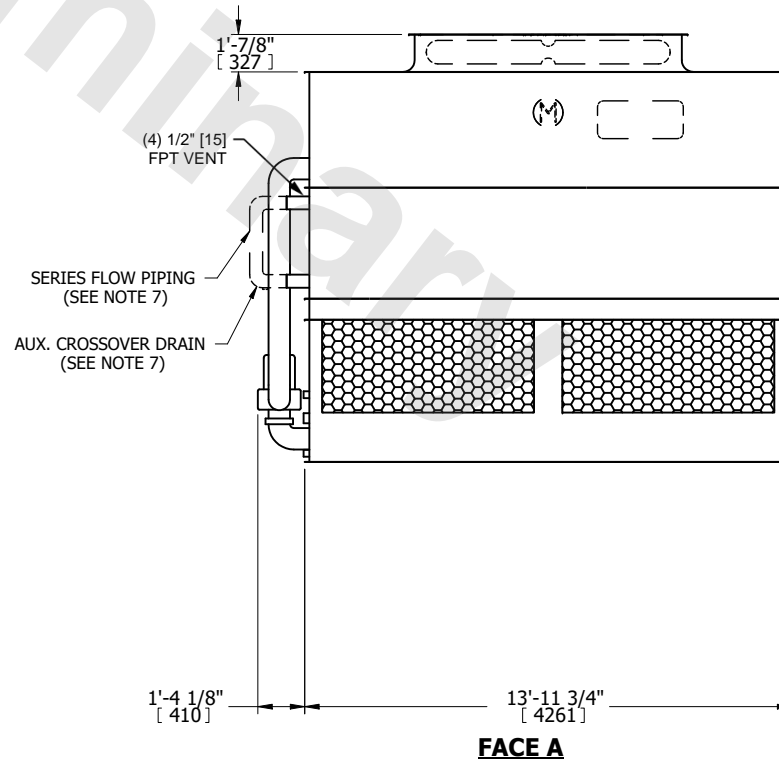
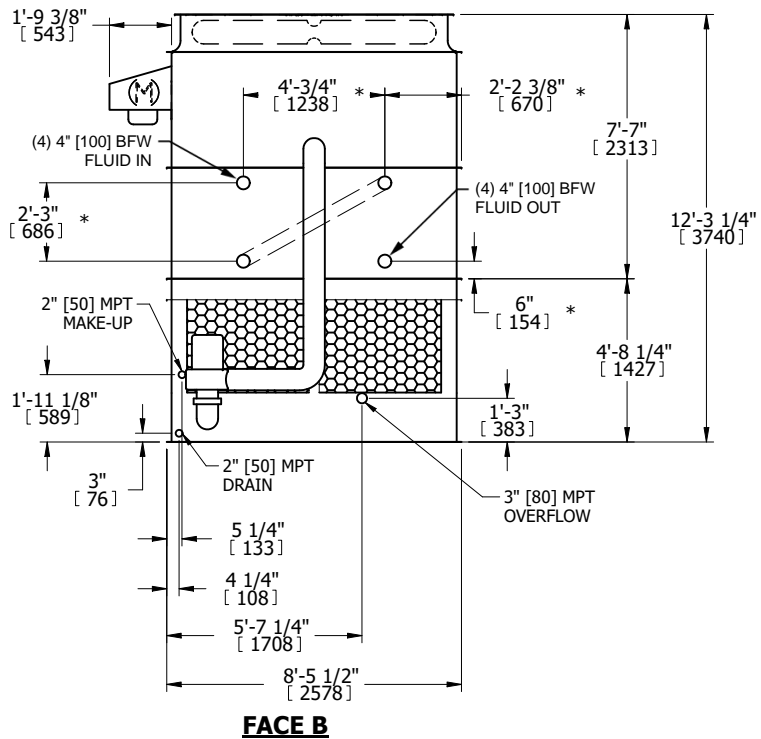
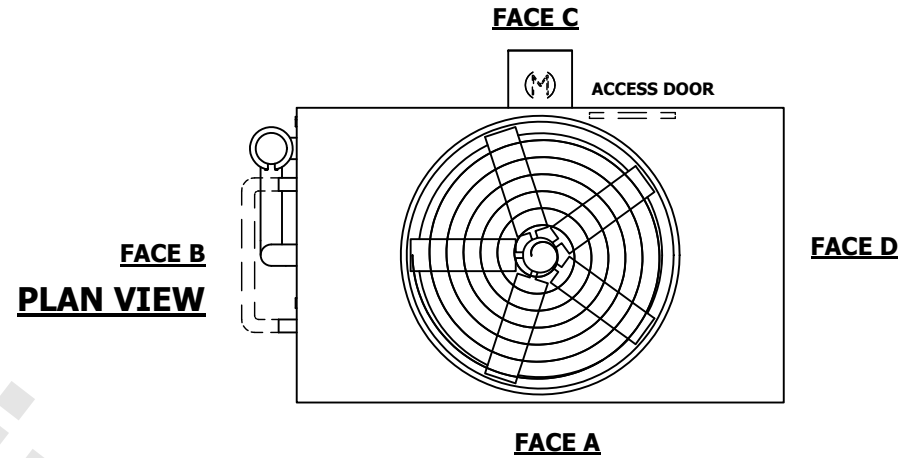

SHIPPING WEIGHT	16250 lbs+ [7375] kg+	OPERATING WEIGHT	23220 lbs+ [10535] kg+	HEAVIEST SECTION WEIGHT	14170 lbs+ [6430] kg+	NO. OF SHIPPING SECTIONS	2	DRAWN BY:	JLG
-----------------	-----------------------	------------------	------------------------	-------------------------	-----------------------	--------------------------	---	-----------	-----