

UNIT	CLOSED CIRCUIT COOLER	
MODEL #	eco-ATWB 12-6L12-Z	SCALE NTS

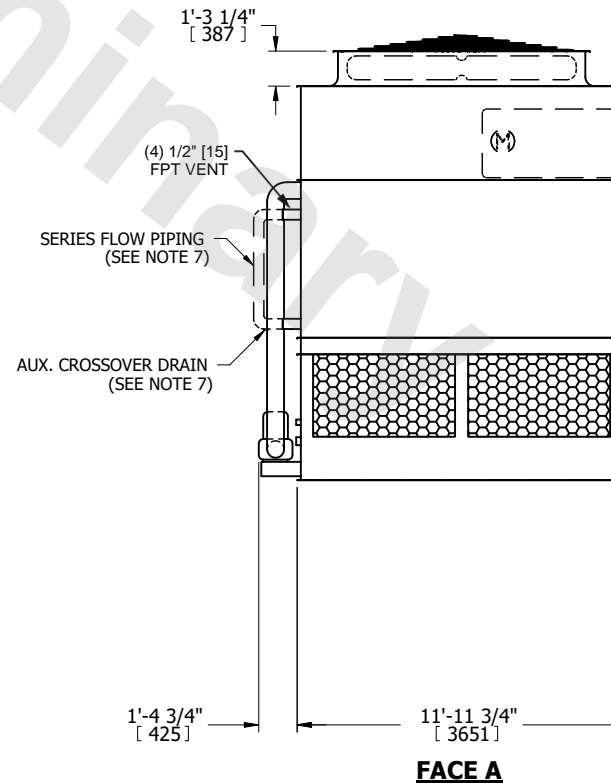

DWG. #	WB3121212-DRC-SF	REV.	-
SERIAL #		DATE	7/9/2026

- NOTES:
- (M) - FAN MOTOR LOCATION
 - HEAVIEST SECTION IS UPPER SECTION
 - MPT DENOTES MALE PIPE THREAD
FPT DENOTES FEMALE PIPE THREAD
BFW DENOTES BEVELED FOR WELDING
GVD DENOTES GROOVED
FLG DENOTES FLANGE
PE DENOTES PLAIN END
 - + UNIT WEIGHT DOES NOT INCLUDE ACCESSORIES (SEE SEPARATE DRAWINGS FOR ACCESSORIES)
 - MAKE-UP WATER PRESSURE
20 psi MIN [137 kPa], 50 psi MAX [344 kPa]
 - * - APPROXIMATE DIMENSIONS DO NOT USE FOR PRE-FABRICATION OF CONNECTING PIPING
 - SERIES FLOW PIPING AND AUX. CROSSOVER DRAIN BY OTHERS
 - 3/4" [19mm] DIA. MOUNTING HOLES. REFER TO RECOMMENDED STEEL SUPPORT DRAWING.
 - DIMENSIONS LISTED AS FOLLOWS:
ENGLISH FT-IN
METRIC [mm]

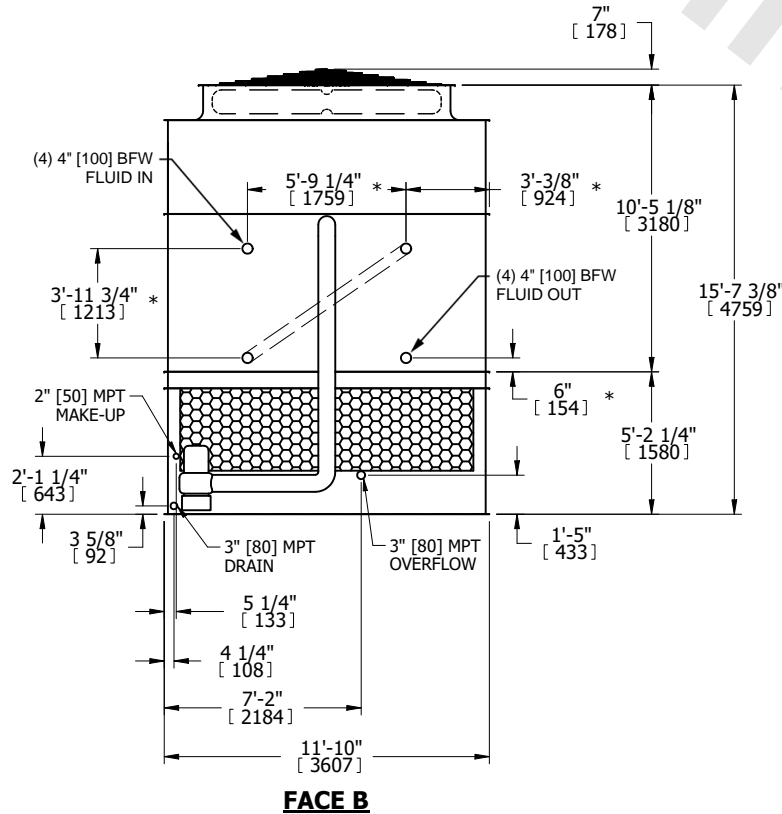
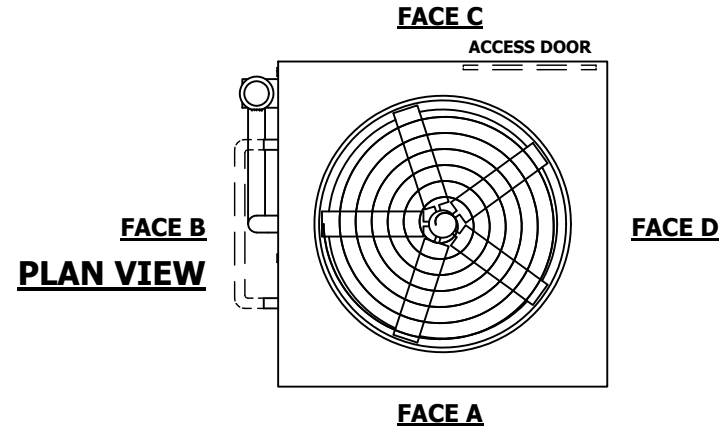

SHIPPING WEIGHT	26470 lbs+ [12010] kg+	OPERATING WEIGHT	37530 lbs+ [17025] kg+	HEAVIEST SECTION WEIGHT	23760 lbs+ [10780] kg+	NO. OF SHIPPING SECTIONS	2	DRAWN BY:	JLG
-----------------	------------------------	------------------	------------------------	-------------------------	------------------------	--------------------------	---	-----------	-----