

UNIT	CLOSED CIRCUIT COOLER	
MODEL #	eco-ATWB 12-6O20-Z	SCALE NTS



DWG. #	WB3122012-DRC-SF	REV.	-
SERIAL #		DATE	4/11/2026

NOTES:

- (M) - FAN MOTOR LOCATION
- HEAVIEST SECTION IS UPPER SECTION
- MPT DENOTES MALE PIPE THREAD
FPT DENOTES FEMALE PIPE THREAD
BFW DENOTES BEVELED FOR WELDING
GVD DENOTES GROOVED
FLG DENOTES FLANGE
PE DENOTES PLAIN END
- + UNIT WEIGHT DOES NOT INCLUDE ACCESSORIES (SEE SEPARATE DRAWINGS FOR ACCESSORIES)
- MAKE-UP WATER PRESSURE
20 psi MIN [137 kPa], 50 psi MAX [344 kPa]
- * - APPROXIMATE DIMENSIONS DO NOT USE FOR PRE-FABRICATION OF CONNECTING PIPING
- SERIES FLOW PIPING AND AUX. CROSSOVER DRAIN BY OTHERS
- 3/4" [19MM] DIA. MOUNTING HOLES. REFER TO RECOMMENDED STEEL SUPPORT DRAWING.
- DIMENSIONS LISTED AS FOLLOWS:

ENGLISH FT-IN
METRIC [mm]

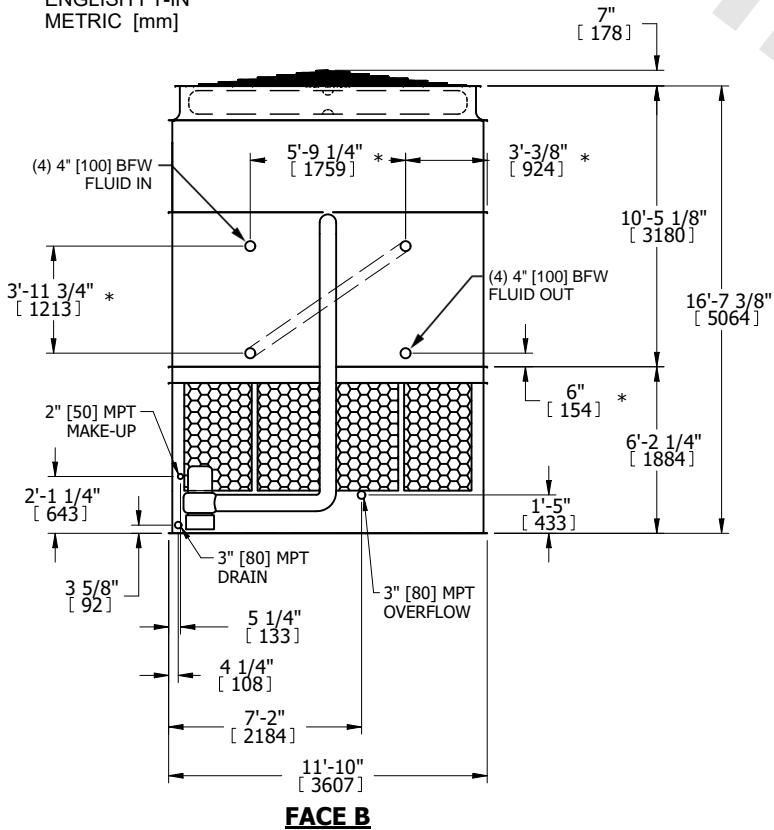

FACE B
PLAN VIEW

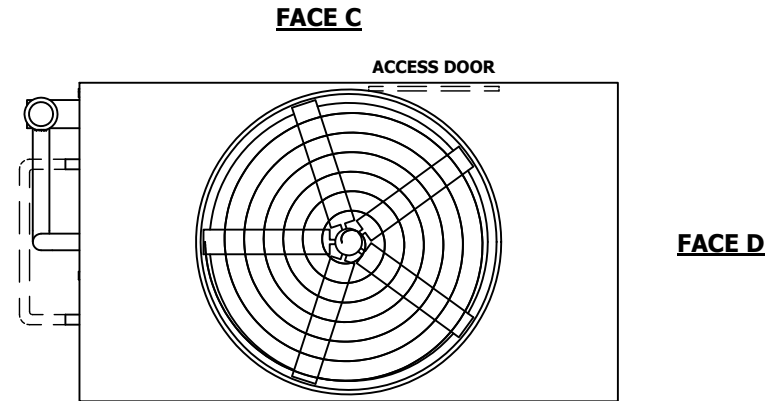

FACE D

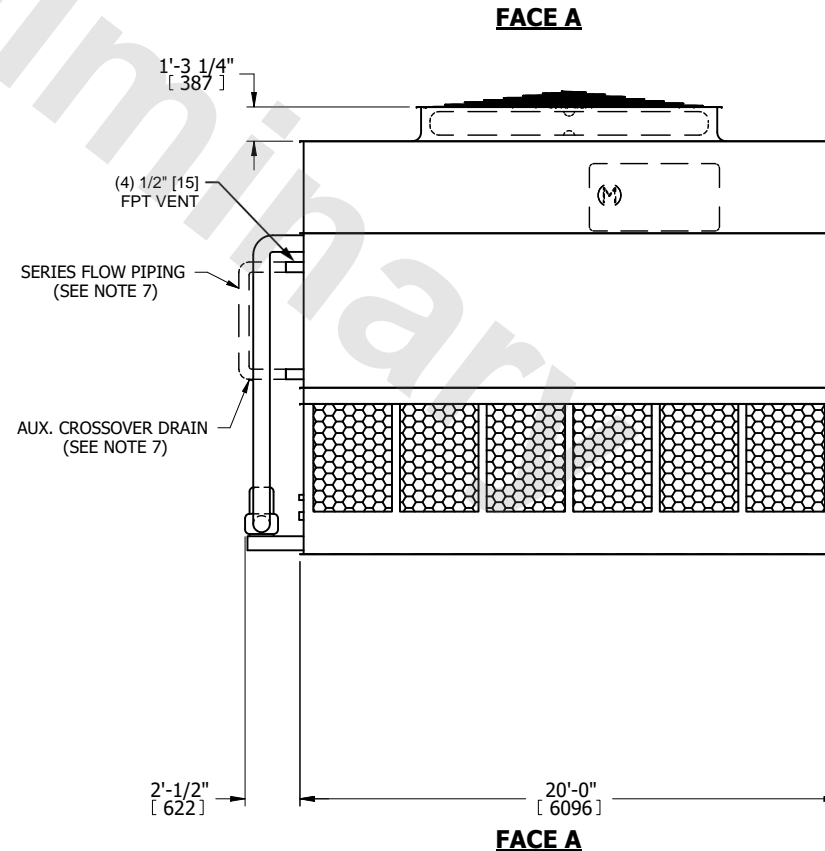

SHIPPING WEIGHT	43110 lbs+ [19555] kg+	OPERATING WEIGHT	61670 lbs+ [27975] kg+	HEAVIEST SECTION WEIGHT	38600 lbs+ [17510] kg+	NO. OF SHIPPING SECTIONS	2	DRAWN BY:	JLG
-----------------	------------------------	------------------	------------------------	-------------------------	------------------------	--------------------------	---	-----------	-----