

UNIT	CLOSED CIRCUIT COOLER	
MODEL #	eco-ATWB 24-5K24-Z	SCALE NTS

# EVAPCO, INC.

DWG. #	WB3242410-DRD-SF	REV.	-
SERIAL #		DATE	5/20/2026

- NOTES:
- (M)- FAN MOTOR LOCATION
  - HEAVIEST SECTION IS UPPER SECTION
  - MPT DENOTES MALE PIPE THREAD  
FPT DENOTES FEMALE PIPE THREAD  
BFW DENOTES BEVELED FOR WELDING  
GVD DENOTES GROOVED  
FLG DENOTES FLANGE  
PE DENOTES PLAIN END
  - +UNIT WEIGHT DOES NOT INCLUDE ACCESSORIES (SEE ACCESSORY DRAWINGS)
  - MAKE-UP WATER PRESSURE  
20 psi MIN [137 kPa], 50 psi MAX [344 kPa]
  - \*-APPROXIMATE DIMENSIONS DO NOT USE FOR PRE-FABRICATION OF CONNECTING PIPING
  - SERIES FLOW PIPING AND AUX. CROSSOVER DRAIN BY OTHERS.
  - 3/4" [19MM] DIA. MOUNTING HOLES. REFER TO RECOMMENDED STEEL SUPPORT DRAWING.
  - DIMENSIONS LISTED AS FOLLOWS:  
ENGLISH FT-IN  
METRIC [MM]

**FACE B  
PLAN VIEW**

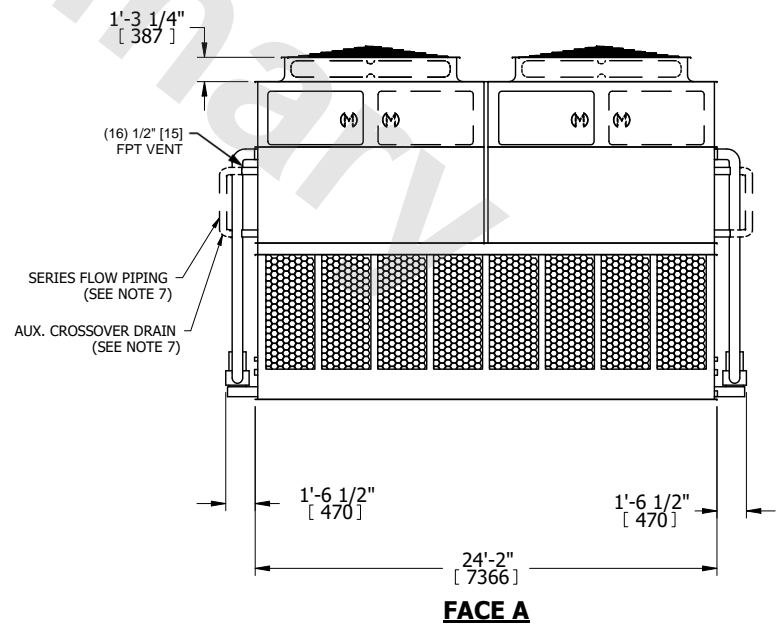
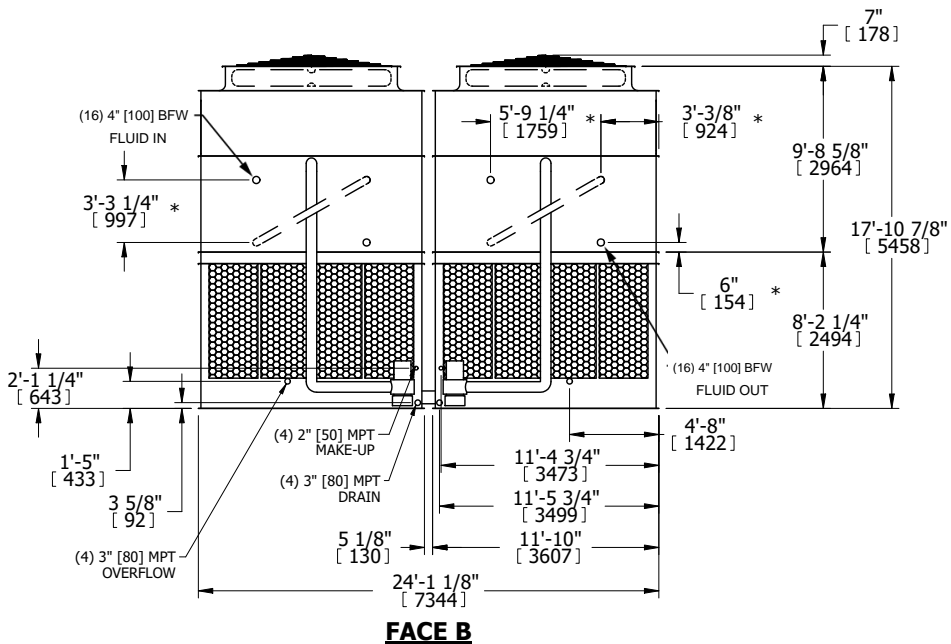

SHIPPING WEIGHT	93300 lbs+ [42325] kg+	OPERATING WEIGHT	134280 lbs+ [60910] kg+	HEAVIEST SECTION WEIGHT	20530 lbs+ [9315] kg+	NO. OF SHIPPING SECTIONS	6	DRAWN BY:	JLG
-----------------	------------------------	------------------	-------------------------	-------------------------	-----------------------	--------------------------	---	-----------	-----