

EVAPCO, INC.



UNIT	CLOSED CIRCUIT COOLER	MODEL #	eco-ATWB-H 17-3L14-Z-U34	SCALE	N.T.S.	DWG. #	EGH1714MR-DRD-SF	REV.	-	DATE	6/21/2026	SERIAL #	
------	-----------------------	---------	--------------------------	-------	--------	--------	------------------	------	---	------	-----------	----------	--

- NOTES:
- (M)- FAN MOTOR LOCATION
 - HEAVIEST SECTION IS COIL SECTION
 - MPT DENOTES MALE PIPE THREAD
FPT DENOTES FEMALE PIPE THREAD
BFW DENOTES BEVELED FOR WELDING
 - +UNIT WEIGHT DOES NOT INCLUDE ACCESSORIES (SEE ACCESSORY DRAWINGS)
 - MAKE-UP WATER PRESSURE
20 psi MIN [137 kPa], 50 psi MAX [344 kPa]

- DIMENSIONS LISTED AS FOLLOWS:
ENGLISH IN
[METRIC] [mm]
- * - APPROXIMATE DIMENSIONS DO NOT USE FOR PRE-FABRICATION OF CONNECTING PIPING.



**FACE 2
PLAN VIEW**

FACE 1

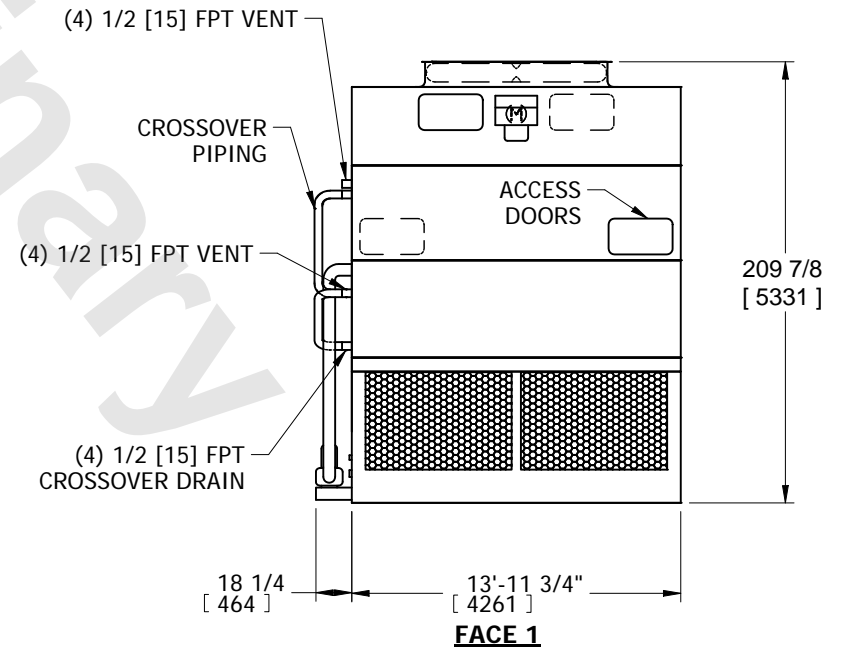

SHIPPING WEIGHT	35630 lbs+ [16165] kg+	OPERATING WEIGHT	48510 lbs+ [22005] kg+	HEAVIEST SECTION WEIGHT	13090 lbs+ [5935] kg+	NO. OF SHIPPING SECTIONS	6	DRAWN BY:	SRF
-----------------	------------------------	------------------	------------------------	-------------------------	-----------------------	--------------------------	---	-----------	-----