

EVAPCO, INC.



UNIT CLOSED CIRCUIT COOLER	MODEL # eco-ATWB-H 10-2L24-Z-U22	SCALE N.T.S.	DWG. # EGHTM24MR-DRB-SF	REV. -	DATE 4/27/2026	SERIAL #
-------------------------------	-------------------------------------	-----------------	----------------------------	-----------	-------------------	----------

- NOTES:
- (M)- FAN MOTOR LOCATION
 - HEAVIEST SECTION IS COIL SECTION
 - MPT DENOTES MALE PIPE THREAD
FPT DENOTES FEMALE PIPE THREAD
BFW DENOTES BEVELED FOR WELDING
 - +UNIT WEIGHT DOES NOT INCLUDE ACCESSORIES (SEE ACCESSORY DRAWINGS)
 - MAKE-UP WATER PRESSURE
20 psi MIN [137 kPa], 50 psi MAX [344 kPa]

6. DIMENSIONS LISTED AS FOLLOWS:
ENGLISH IN
[METRIC] [mm]
7. * - APPROXIMATE DIMENSIONS DO NOT USE FOR PRE-FABRICATION OF CONNECTING PIPING.

**FACE 2
PLAN VIEW**



FACE 1

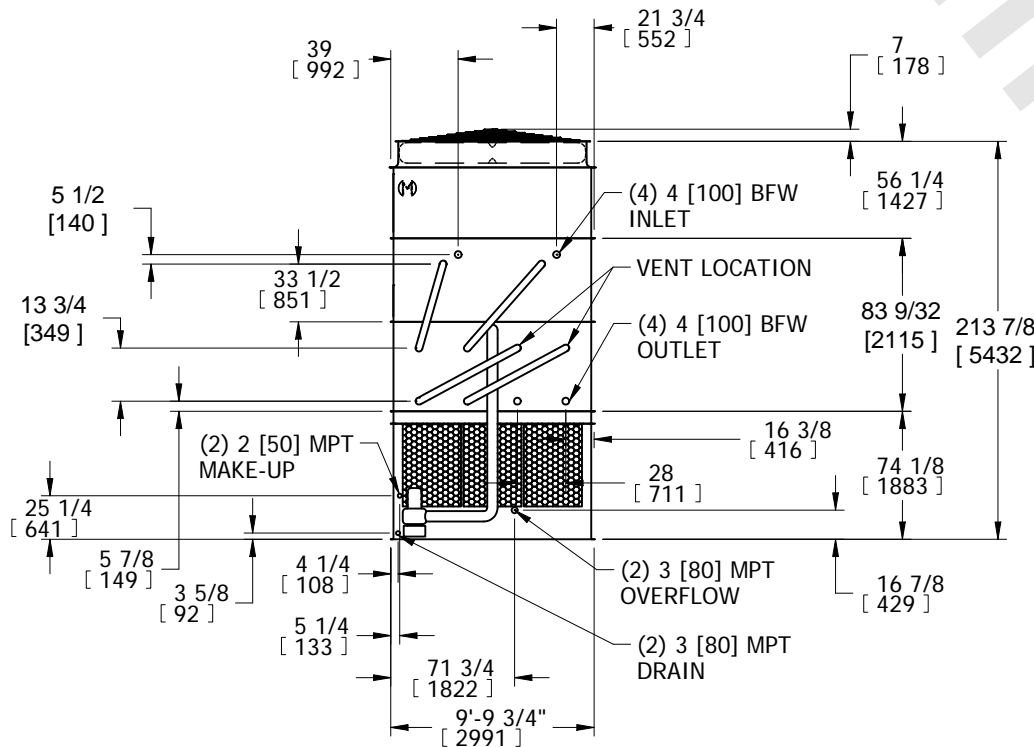

FACE 2

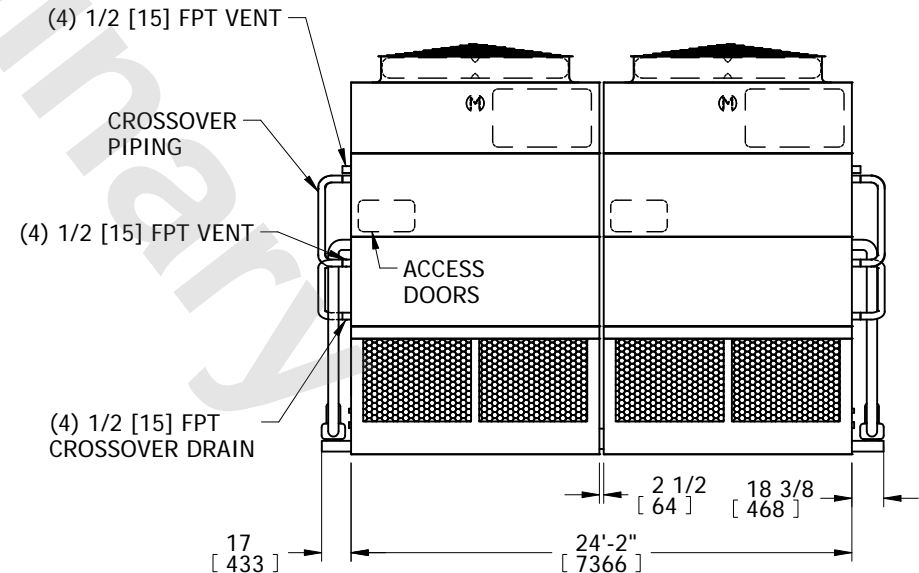

FACE 1

SHIPPING WEIGHT 33670 lbs+ [15275] kg+	OPERATING WEIGHT 45210 lbs+ [20510] kg+	HEAVIEST SECTION WEIGHT 10840 lbs+ [4915] kg+	NO. OF SHIPPING SECTIONS 6	DRAWN BY: SFR
---	--	--	-------------------------------	------------------