

EVAPCO, INC.



| | | | | | | | | | | | | | |
|------|-----------------------|---------|-----------------------|-------|-------|--------|------------------|------|---|------|-----------|----------|--|
| UNIT | CLOSED CIRCUIT COOLER | MODEL # | eco-ATWB-H 9-3K14-U34 | SCALE | N.T.S | DWG. # | EGH0914MR-DRC-ST | REV. | - | DATE | 6/17/2026 | SERIAL # | |
|------|-----------------------|---------|-----------------------|-------|-------|--------|------------------|------|---|------|-----------|----------|--|

- NOTES:
- (M)- FAN MOTOR LOCATION
 - HEAVIEST SECTION IS COIL SECTION
 - MPT DENOTES MALE PIPE THREAD
FPT DENOTES FEMALE PIPE THREAD
BFW DENOTES BEVELED FOR WELDING
 - +UNIT WEIGHT DOES NOT INCLUDE ACCESSORIES (SEE ACCESSORY DRAWINGS)
 - MAKE-UP WATER PRESSURE
20 psi MIN [137 kPa], 50 psi MAX [344 kPa]

- DIMENSIONS LISTED AS FOLLOWS:
ENGLISH IN
[METRIC] [mm]
- * - APPROXIMATE DIMENSIONS DO NOT USE FOR PRE-FABRICATION OF CONNECTING PIPING.

**FACE 2
PLAN VIEW**



FACE 1

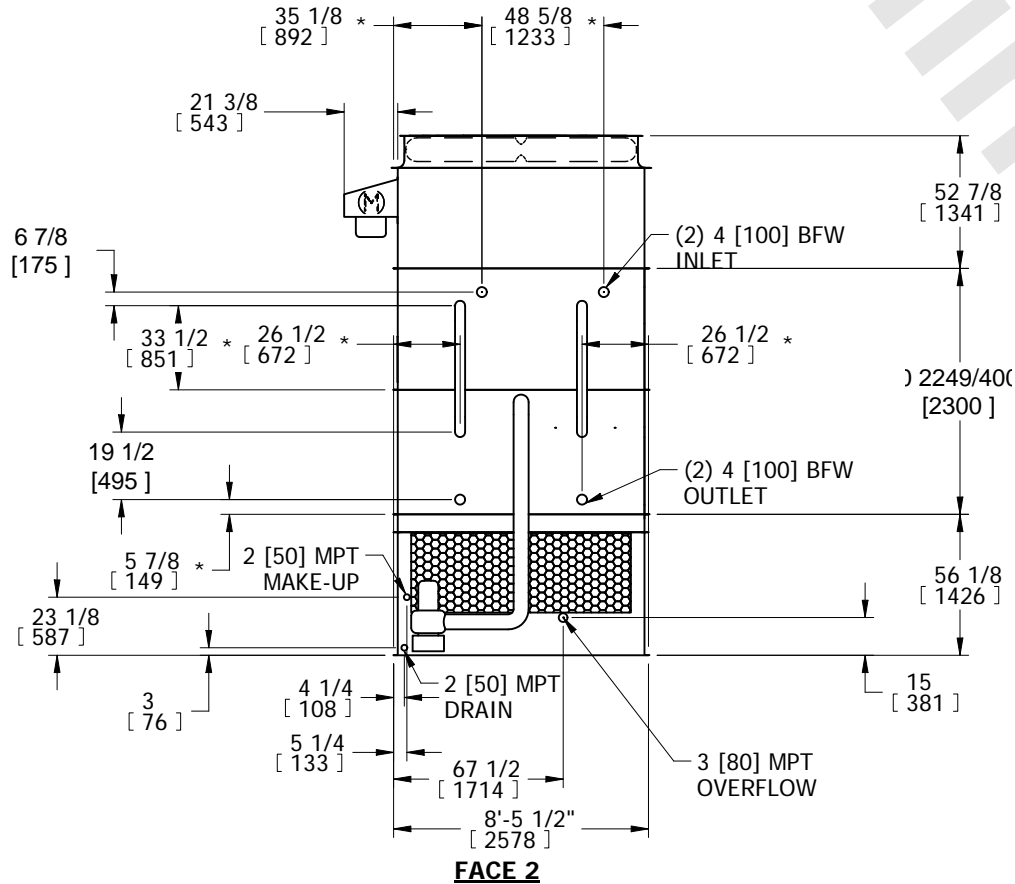

FACE 2

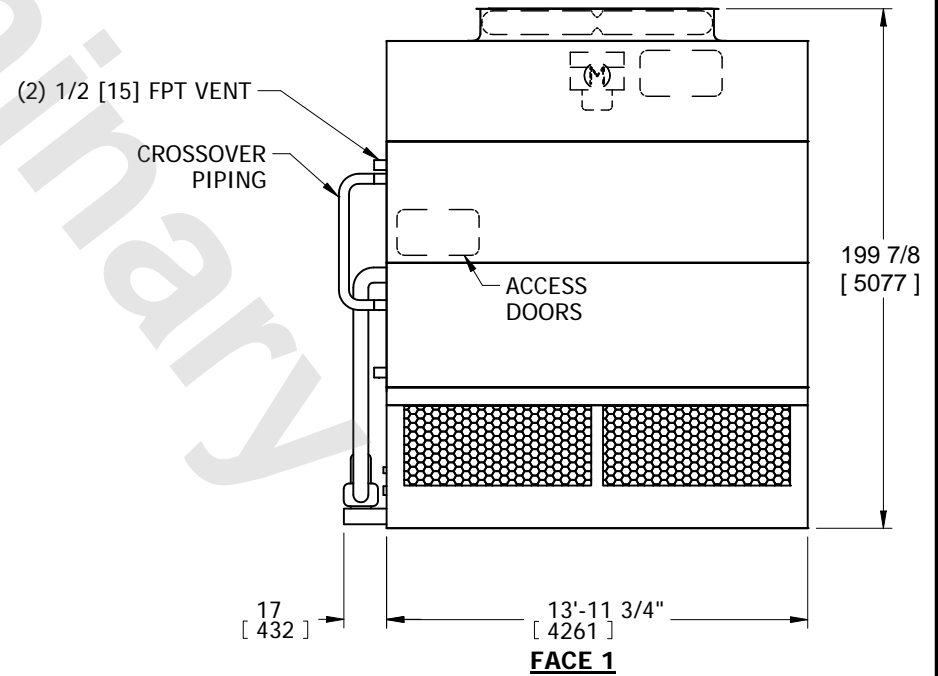

FACE 1

| | | | | | | | | | |
|-----------------|-----------------------|------------------|------------------------|-------------------------|-----------------------|--------------------------|---|-----------|-----|
| SHIPPING WEIGHT | 17780 lbs+ [8065] kg+ | OPERATING WEIGHT | 24220 lbs+ [10990] kg+ | HEAVIEST SECTION WEIGHT | 13090 lbs+ [5935] kg+ | NO. OF SHIPPING SECTIONS | 3 | DRAWN BY: | SFR |
|-----------------|-----------------------|------------------|------------------------|-------------------------|-----------------------|--------------------------|---|-----------|-----|