

EVAPCO, INC.



UNIT COOLING TOWER	MODEL # LSTE-5418	SCALE N.T.S.	DWG. # TLE051836-DRA-ST	REV. -	DATE 5/25/2026	SERIAL #
------------------------------	----------------------	-----------------	----------------------------	-----------	-------------------	----------

- NOTES:
- (M)- FAN MOTOR LOCATION
 - HEAVIEST SECTION IS LOWER SECTION
 - MPT DENOTES MALE PIPE THREAD
FPT DENOTES FEMALE PIPE THREAD
BFW DENOTES BEVELED FOR WELDING
GVD DENOTES GROOVED FOR VICTAULIC
 - +UNIT WEIGHT DOES NOT INCLUDE ACCESSORIES (SEE ACCESSORY DRAWINGS)
 - MAKE-UP WATER PRESSURE
20 psi MIN [137 kPa], 50 psi MAX [344 kPa]
 - 3/4" [19mm] DIA. MOUNTING HOLES. REFER TO RECOMMENDED STEEL SUPPORT DRAWING
 - DIMENSIONS LISTED AS FOLLOWS: ENGLISH IN [METRIC] [mm]
 - MAKE-UP CONNECTION LOCATED 33" FROM CONNECTION END OF UNIT

**FACE 1
PLAN VIEW**

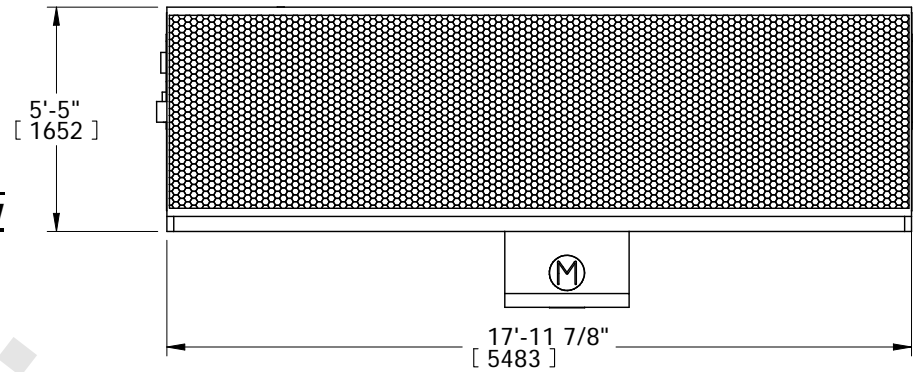

FACE 2

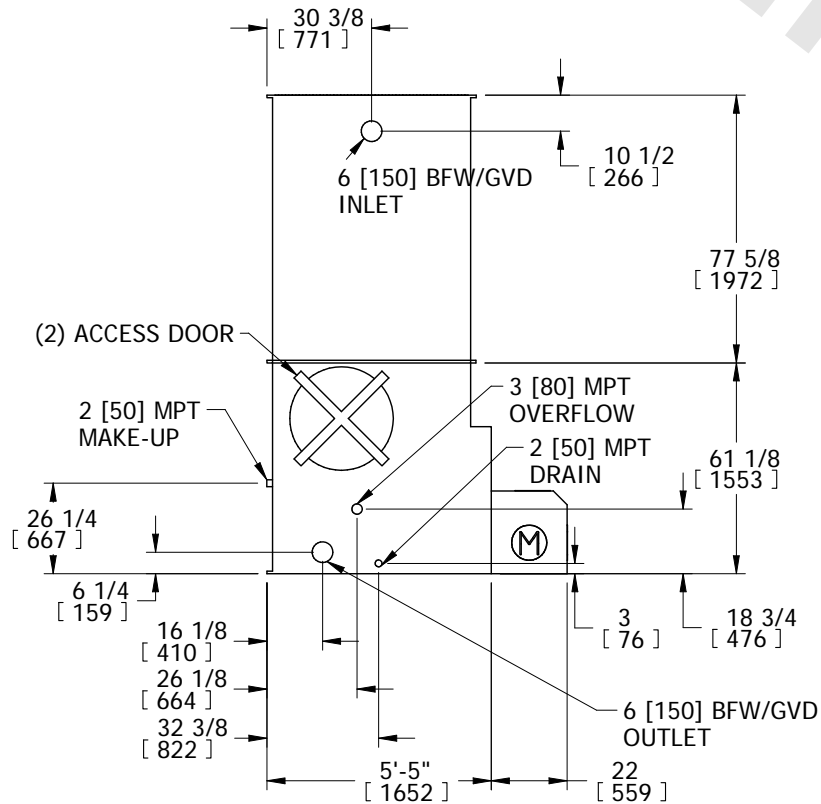

FACE 1

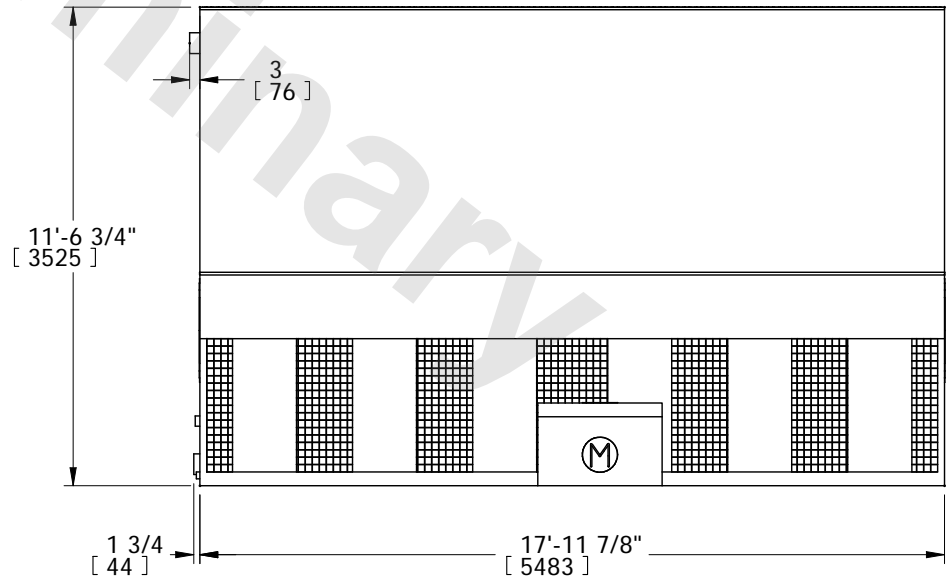

FACE 2

SHIPPING WEIGHT 6530 lbs+ [2962] kg+	OPERATING WEIGHT 9720 lbs+ [4409] kg+	HEAVIEST SECTION WEIGHT 3910 lbs+ [1774] kg+	NO. OF SHIPPING SECTIONS 2
---	--	---	-------------------------------