

UNIT	COOLING TOWER	
MODEL #	AXS 12-11022	SCALE



DWG. #	AX122209-DRC-ST	REV.	-
SERIAL #		DATE	4/29/2026

- NOTES:
- (M)- FAN MOTOR LOCATION
 - MPT DENOTES MALE PIPE THREAD
FPT DENOTES FEMALE PIPE THREAD
BFW DENOTES BEVELED FOR WELDING
GVD DENOTES GROOVED
 - +UNIT WEIGHT DOES NOT INCLUDE ACCESSORIES (SEE ACCESSORY DRAWINGS)
 - MAKE-UP WATER PRESSURE
20 psi MIN [137 kPa], 50 psi MAX [344 kPa]
 - 3/4" DIA. MOUNTING HOLES. REFER TO RECOMMENDED STEEL SUPPORT DRAWING.
 - DIMENSIONS LISTED AS FOLLOWS: ENGLISH IN [METRIC] [mm]

**FACE B
PLAN VIEW**

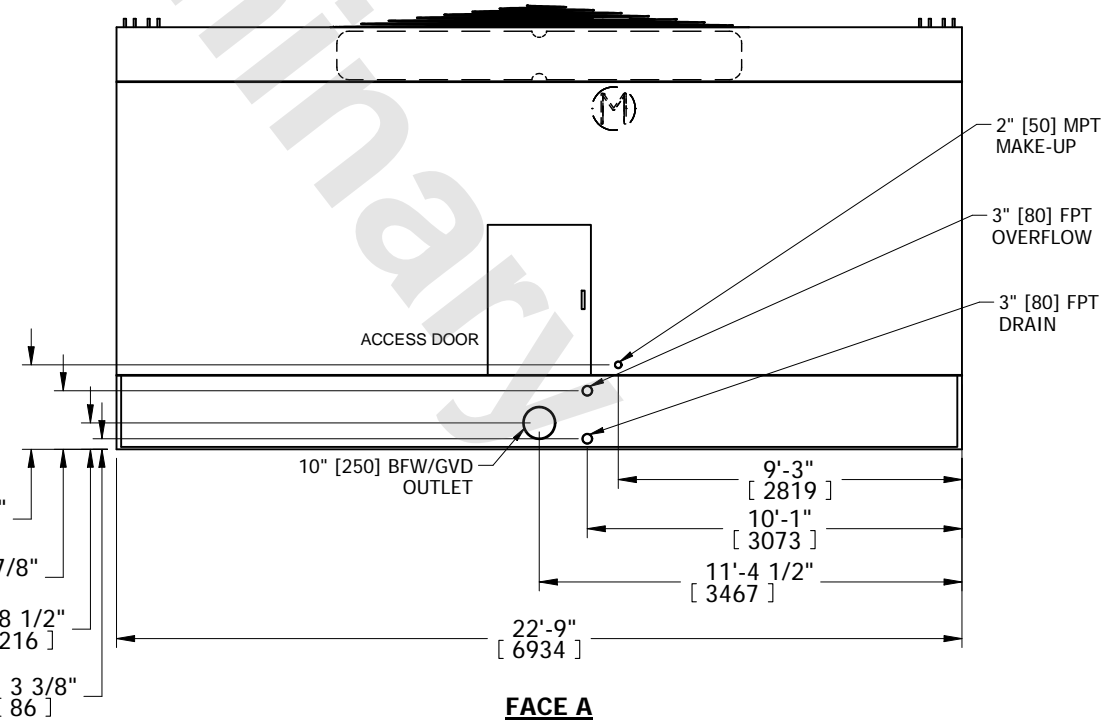
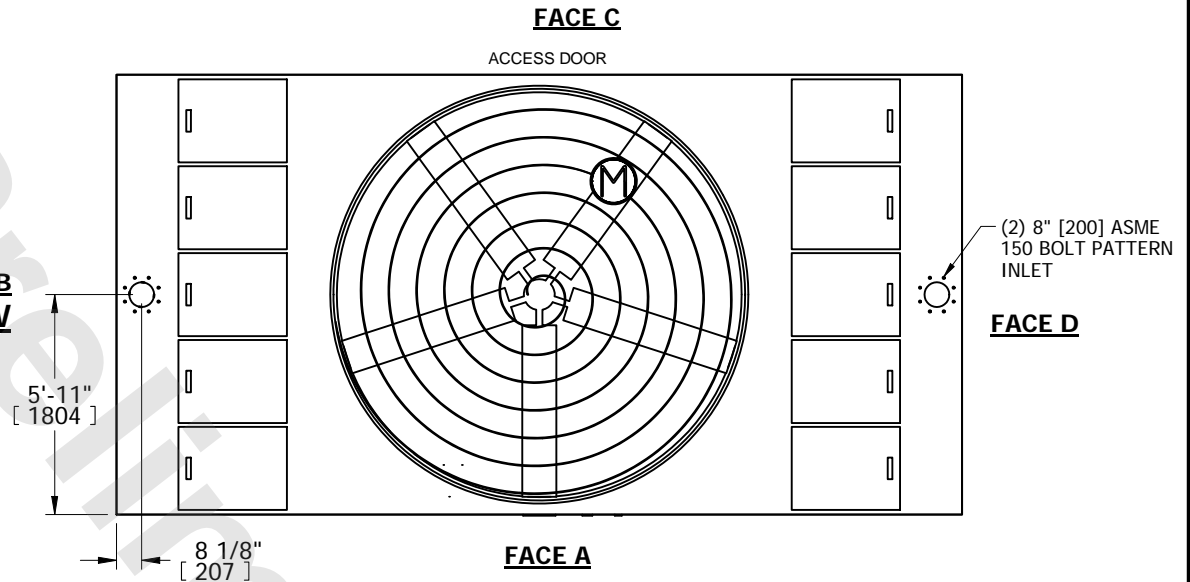
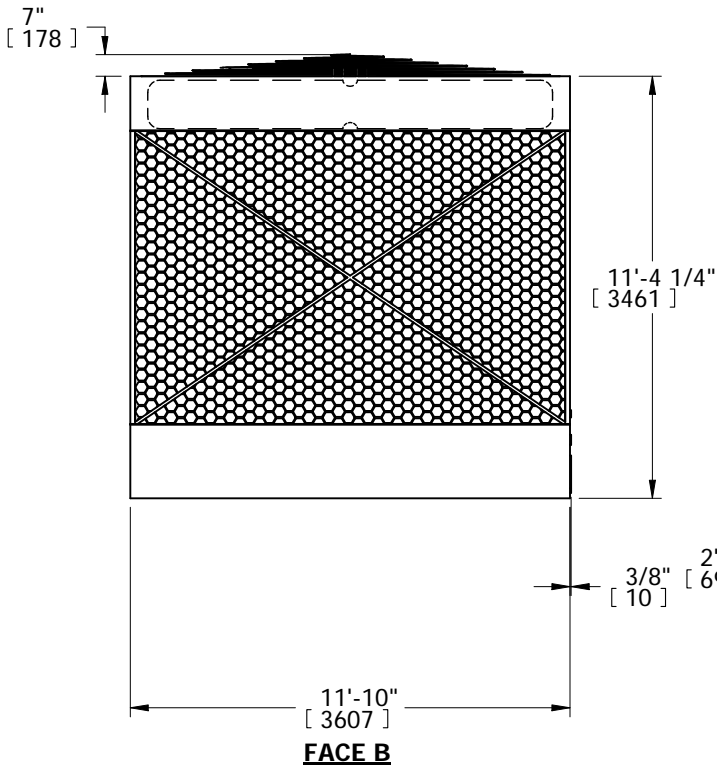

SHIPPING WEIGHT	12400 lbs+ [5625] kg+	OPERATING WEIGHT	26590 lbs+ [12065] kg+	HEAVIEST SECTION WEIGHT	12400 lbs+ [5625] kg+	NO. OF SHIPPING SECTIONS	1	DRAWN BY:	JLM
-----------------	-----------------------	------------------	------------------------	-------------------------	-----------------------	--------------------------	---	-----------	-----