

UNIT	<b>COOLING TOWER</b>	
MODEL #	AXS 12-22K22	SCALE

# EVAPCO, INC.



DWG. #	AX122220-DRB-ST	REV.	-
SERIAL #		DATE	4/29/2026

- NOTES:
1. (M)- FAN MOTOR LOCATION
  2. HEAVIEST SECTION IS UPPER SECTION
  3. MPT DENOTES MALE PIPE THREAD  
FPT DENOTES FEMALE PIPE THREAD  
BFW DENOTES BEVELED FOR WELDING  
GVD DENOTES GROOVED
  4. +UNIT WEIGHT DOES NOT INCLUDE ACCESSORIES (SEE ACCESSORY DRAWINGS)
  5. MAKE-UP WATER PRESSURE  
20 psi MIN [137 kPa], 50 psi MAX [344 kPa]
  6. 3/4" DIA. MOUNTING HOLES. REFER TO RECOMMENDED STEEL SUPPORT DRAWING.
  7. DIMENSIONS LISTED AS FOLLOWS: ENGLISH IN [METRIC] [mm]

**FACE B  
PLAN VIEW**



**FACE B**

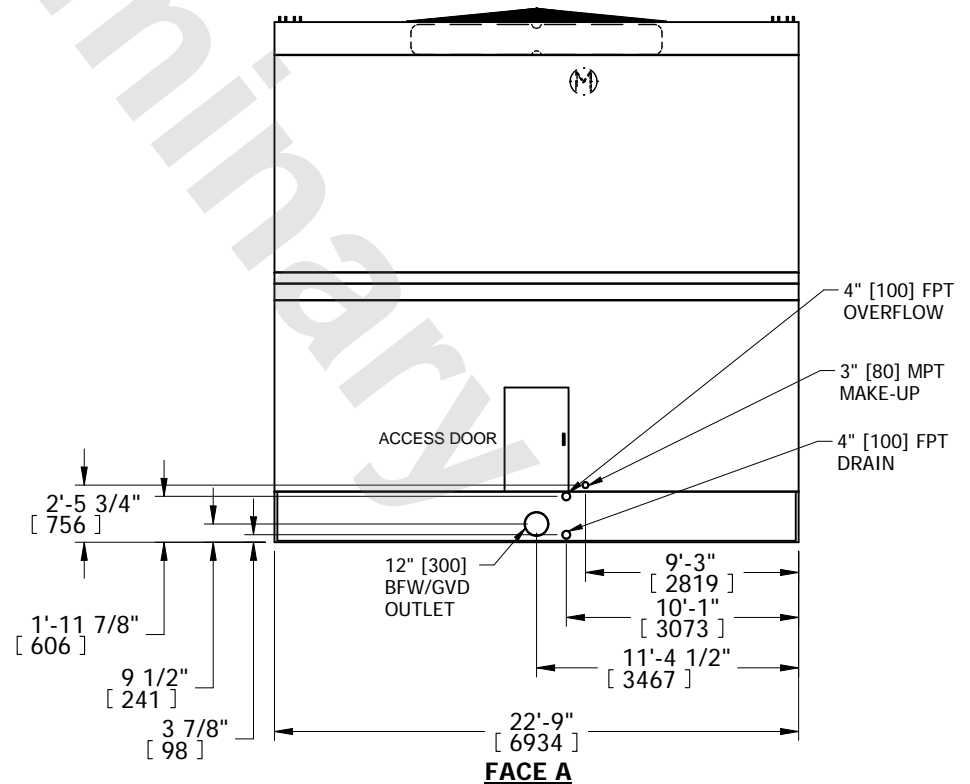

**FACE A**

SHIPPING WEIGHT	18990 lbs+ [8615] kg+	OPERATING WEIGHT	39930 lbs+ [18115] kg+	HEAVIEST SECTION WEIGHT	10540 lbs+ [4785] kg+	NO. OF SHIPPING SECTIONS	2	DRAWN BY:	JLM
-----------------	-----------------------	------------------	------------------------	-------------------------	-----------------------	--------------------------	---	-----------	-----