

UNIT	CONDENSER	
MODEL #	LRC-128	SCALE NTS



DWG. #	WV050906-DRC-ST	REV.	-
SERIAL #		DATE	6/9/2026

- NOTES:
1. (M)- FAN MOTOR LOCATION
 2. MPT DENOTES MALE PIPE THREAD
FPT DENOTES FEMALE PIPE THREAD
BFW DENOTES BEVELED FOR WELDING
GVD DENOTES GROOVED
FLG DENOTES FLANGE
PE DENOTES PLAIN END
 3. +UNIT WEIGHT DOES NOT INCLUDE ACCESSORIES (SEE ACCESSORY DRAWINGS)
 4. 3/4" [19mm] DIA. MOUNTING HOLES. REFER TO RECOMMENDED STEEL SUPPORT DRAWING
 5. DIMENSIONS LISTED AS FOLLOWS: ENGLISH FT IN [METRIC] [mm]
 6. * - APPROXIMATE DIMENSIONS DO NOT USE FOR PRE-FABRICATION OF CONNECTING PIPING
 7. MAKE-UP WATER PRESSURE
20 psi [137 kPa] MIN, 50 psi [344 kPa] MAX

FACE B
PLAN VIEW

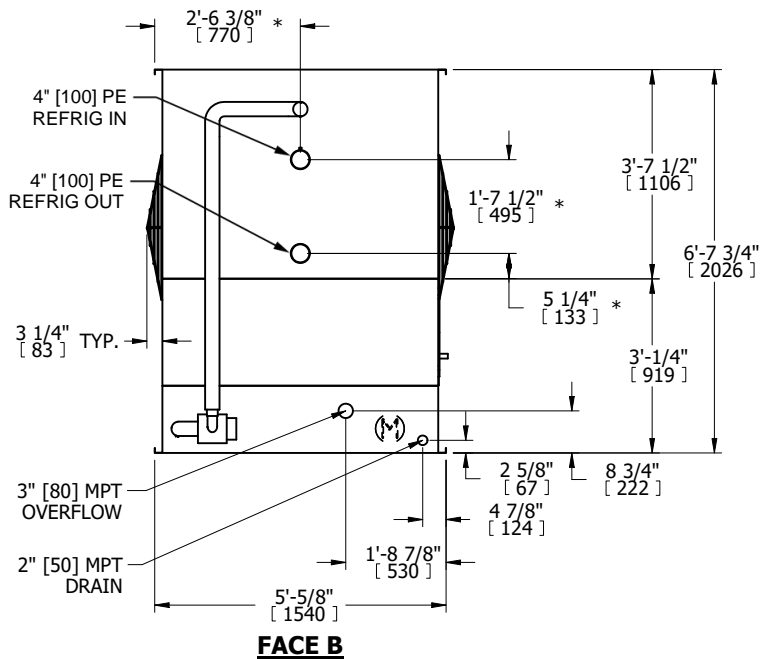
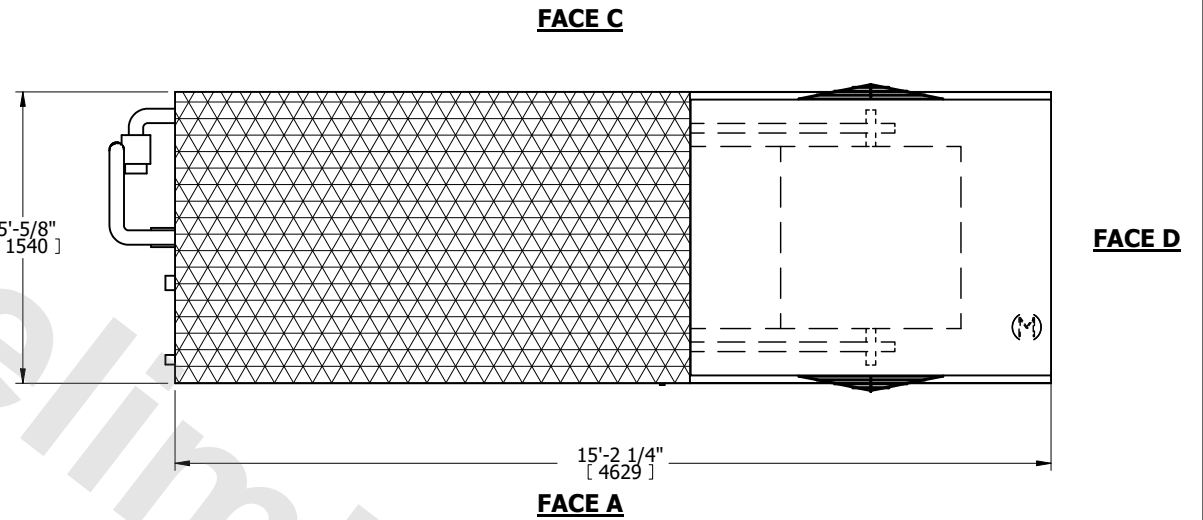

FACE B

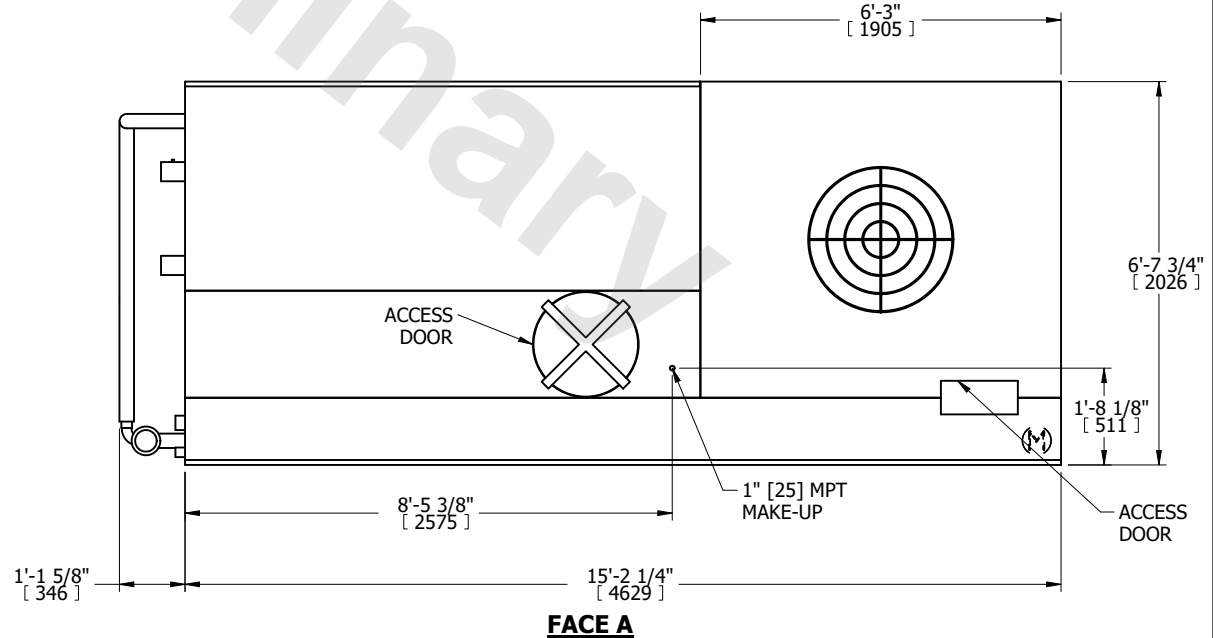

FACE A

SHIPPING WEIGHT	5400 lbs+ [2450] kg+	OPERATING WEIGHT	8210 lbs+ [3725] kg+	HEAVIEST SECTION WEIGHT	5400 lbs+ [2450] kg+	NO. OF SHIPPING SECTIONS	1	DRAWN BY:	TLS
-----------------	----------------------	------------------	----------------------	-------------------------	----------------------	--------------------------	---	-----------	-----