

**CONFIDENTIAL**

This document is the property of Evapco, Inc. It should not be copied or disclosed without prior written authorization.

**EVAPCO, INC.**



CUSTOMER	MODEL # SSTMB4-37103E0100F1KA	SCALE N.T.S.	DWG. # STMC4-SE-16	REV. 0	DATE 7/2/2026
----------	-------------------------------	--------------	--------------------	--------	---------------

NOTES:

- 1) \* = HANGER HOLE LOCATION.
- 2) RIGHT HAND MODEL SHOWN.
- 3) HANGER HOLES ARE FOR 3/4 INCH THREADED ROD.
- 4) WATER DEFROST ADDS 1 3/4" INCHES TO HEIGHT OF STANDARD UNIT AND CHANGES DRAIN SIZE.
- 5) ALL DIMENSIONS ARE FOR REFERENCE AND SHOULD NOT BE USED FOR PREFABRICATION OF PIPING OR SUPPORTS.

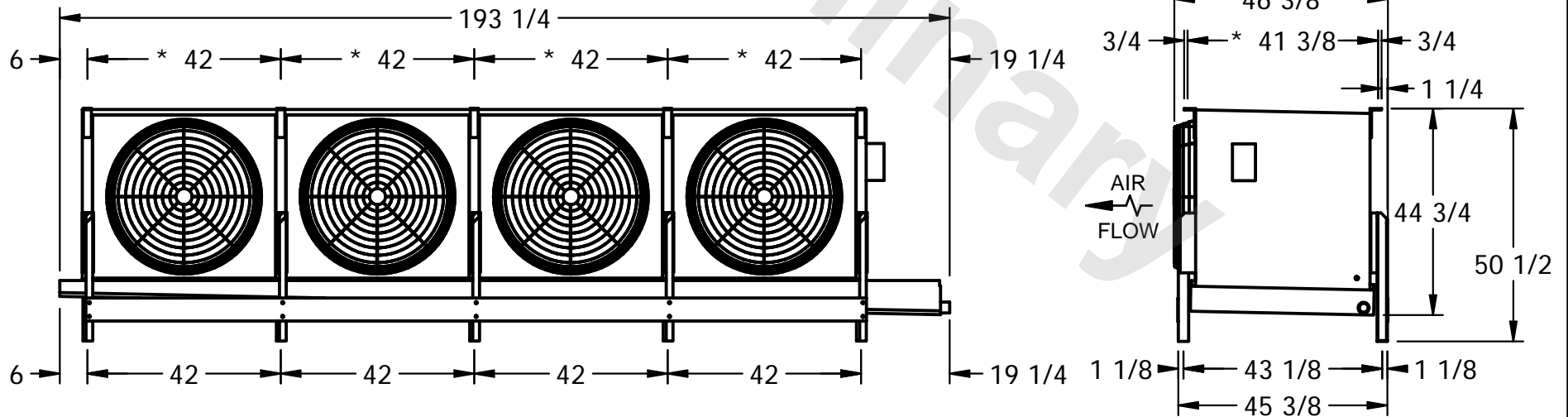
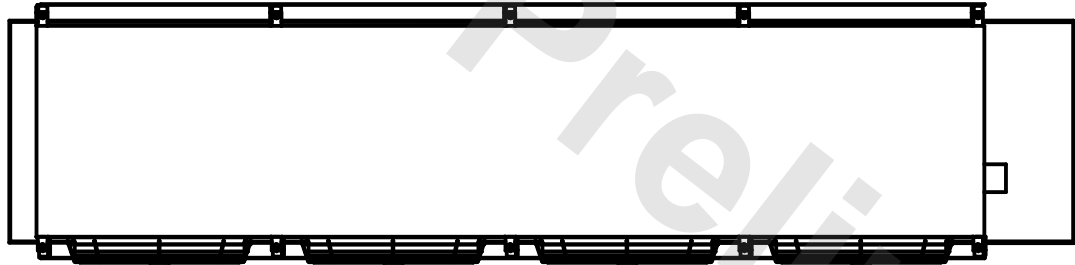

PROJECT	ROOM	SHIPPING WEIGHT 2110 lbs	OPERATING WEIGHT 2550 lbs
---------	------	--------------------------	---------------------------