

CONFIDENTIAL

This document is the property of Evapco, Inc. It should not be copied or disclosed without prior written authorization.

EVAPCO, INC.



| | | | | | |
|----------|------------------------------|--------------|--------------------|--------|----------------|
| CUSTOMER | MODEL # SSTXB2-1484H0075A1MA | SCALE N.T.S. | DWG. # STXC2-SE-12 | REV. 1 | DATE 5/15/2026 |
|----------|------------------------------|--------------|--------------------|--------|----------------|



NOTES:

- 1) * = HANGER HOLE LOCATION.
- 2) RIGHT HAND MODEL SHOWN.
- 3) HANGER HOLES ARE FOR 3/4 INCH THREADED ROD.
- 4) WATER DEFROST ADDS 6 1/2" INCHES TO HEIGHT AND 5" INCHES TO WIDTH OF STANDARD UNIT AND CHANGES THE DRAIN SIZE.
- 5) ALL DIMENSIONS ARE FOR REFERENCE AND SHOULD NOT BE USED FOR PREFABRICATION OF PIPING OR SUPPORTS.

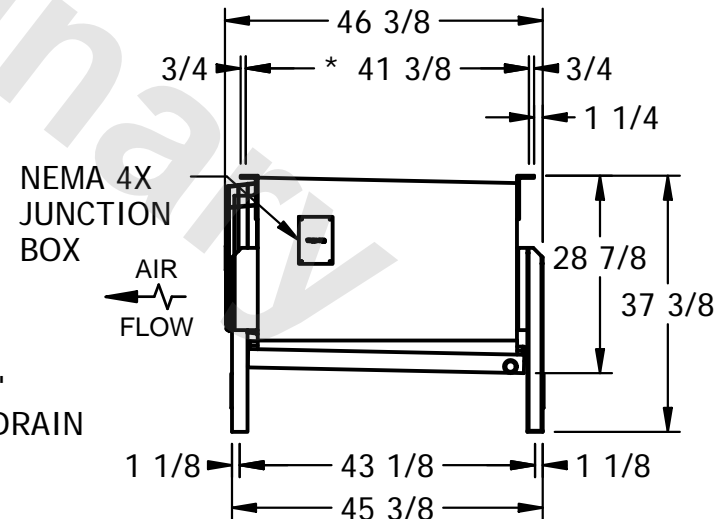

| | | | |
|---------|------|--------------------------|---------------------------|
| PROJECT | ROOM | SHIPPING WEIGHT 1030 lbs | OPERATING WEIGHT 1170 lbs |
|---------|------|--------------------------|---------------------------|