

EVAPCO, INC.



UNIT EVAPORATIVE CONDENSER	MODEL # PHC-S896	SCALE	DWG. # HCS123610-DRC-ST	REV. -	DATE 7/10/2026	SERIAL #
--------------------------------------	---------------------	-------	----------------------------	-----------	-------------------	----------

NOTES:

- (M)- FAN MOTOR LOCATION
- HEAVIEST SECTION IS UPPER SECTION
- MPT DENOTES MALE PIPE THREAD
FPT DENOTES FEMALE PIPE THREAD
BFW DENOTES BEVELED FOR WELDING
GVD DENOTES GROOVED
- +UNIT WEIGHT DOES NOT INCLUDE ACCESSORIES (SEE ACCESSORY DRAWINGS)
- MAKE-UP WATER PRESSURE
20 psi MIN [137 kPa], 50 psi MAX [344 kPa]
- 3/4" DIA. MOUNTING HOLES. REFER TO RECOMMENDED STEEL SUPPORT DRAWING.
- *- APPROXIMATE DIMENSIONS DO NOT USE FOR PRE-FABRICATION OF CONNECTION PIPING.
- **-UNITS WITH 20HP PER FAN REQUIRE A TALLER FAN CYLINDER, ADD 5" TO THESE DIMENSIONS.
- DIMENSIONS LISTED AS FOLLOWS: ENGLISH IN [METRIC] [mm]

FACE 2
PLAN VIEW

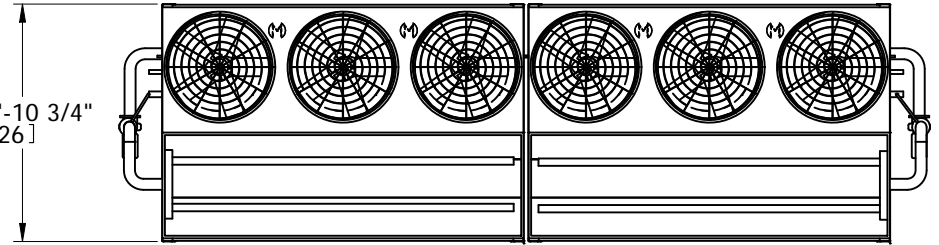

FACE 1

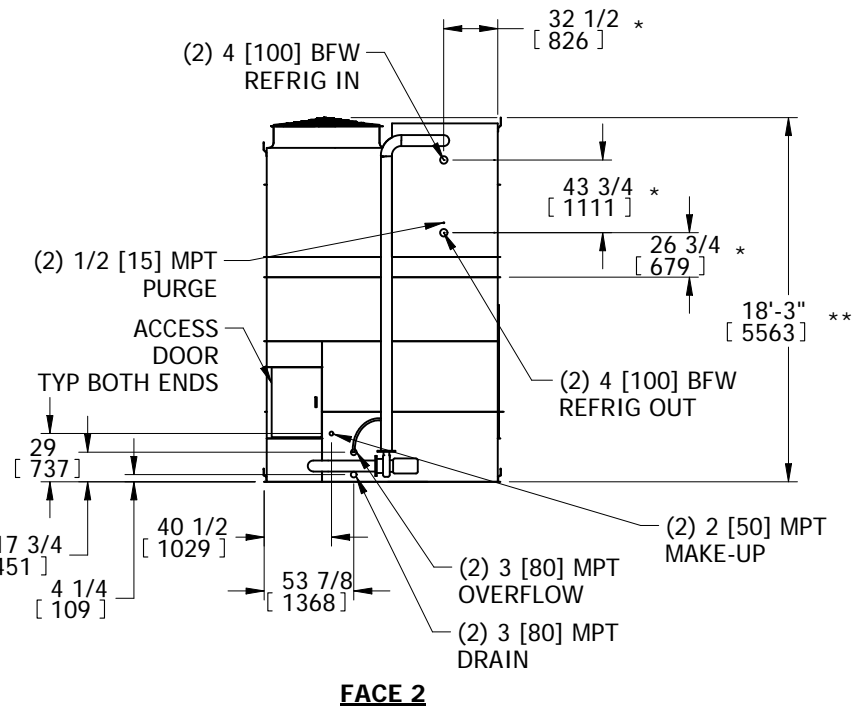

FACE 2

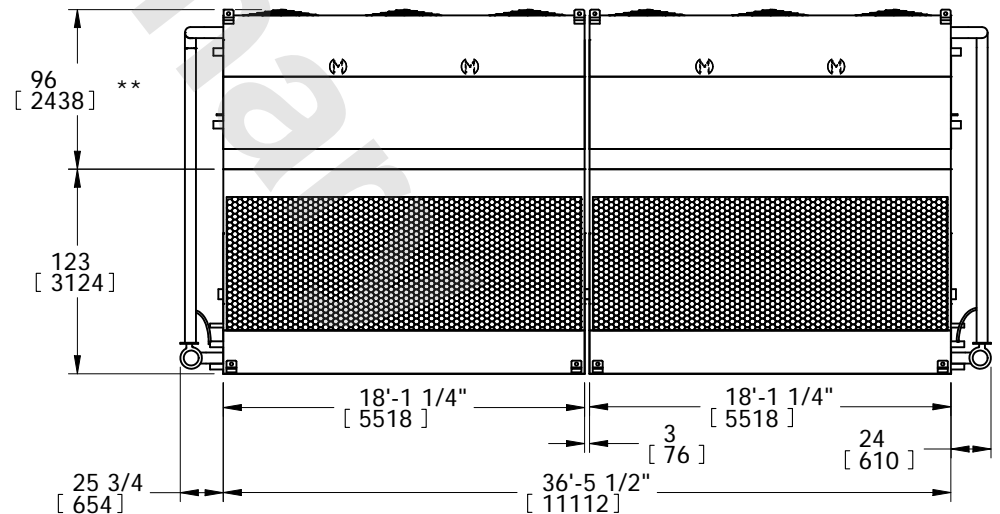

FACE 1

SHIPPING WEIGHT 39500 lbs+ [17920] kg+	OPERATING WEIGHT 55420 lbs+ [25140] kg+	HEAVIEST SECTION WEIGHT 12760 lbs+ [5790] kg+	NO. OF SHIPPING SECTIONS 4	DRAWN BY: TLS
---	--	--	-------------------------------	------------------