

EVAPCO, INC.



UNIT EVAPORATIVE CONDENSER	MODEL # PHC-S956	SCALE	DWG. # HCS123612-DRC-ST	REV. -	DATE 7/10/2026	SERIAL #
--------------------------------------	---------------------	-------	----------------------------	-----------	-------------------	----------

- NOTES:
- (M)- FAN MOTOR LOCATION
 - HEAVIEST SECTION IS UPPER SECTION
 - MPT DENOTES MALE PIPE THREAD
FPT DENOTES FEMALE PIPE THREAD
BFW DENOTES BEVELED FOR WELDING
GVD DENOTES GROOVED
 - +UNIT WEIGHT DOES NOT INCLUDE ACCESSORIES (SEE ACCESSORY DRAWINGS)
 - MAKE-UP WATER PRESSURE
20 psi MIN [137 kPa], 50 psi MAX [344 kPa]
 - 3/4" DIA. MOUNTING HOLES. REFER TO RECOMMENDED STEEL SUPPORT DRAWING.
 - *- APPROXIMATE DIMENSIONS DO NOT USE FOR PRE-FABRICATION OF CONNECTION PIPING.
 - **-UNITS WITH 20HP PER FAN REQUIRE A TALLER FAN CYLINDER, ADD 5" TO THESE DIMENSIONS.
 - DIMENSIONS LISTED AS FOLLOWS: ENGLISH IN [METRIC] [mm]

FACE 2
PLAN VIEW

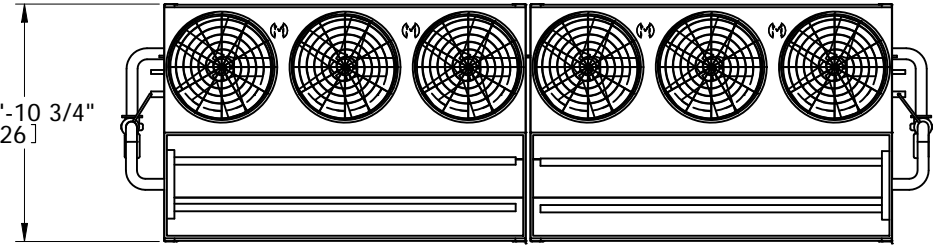

FACE 1

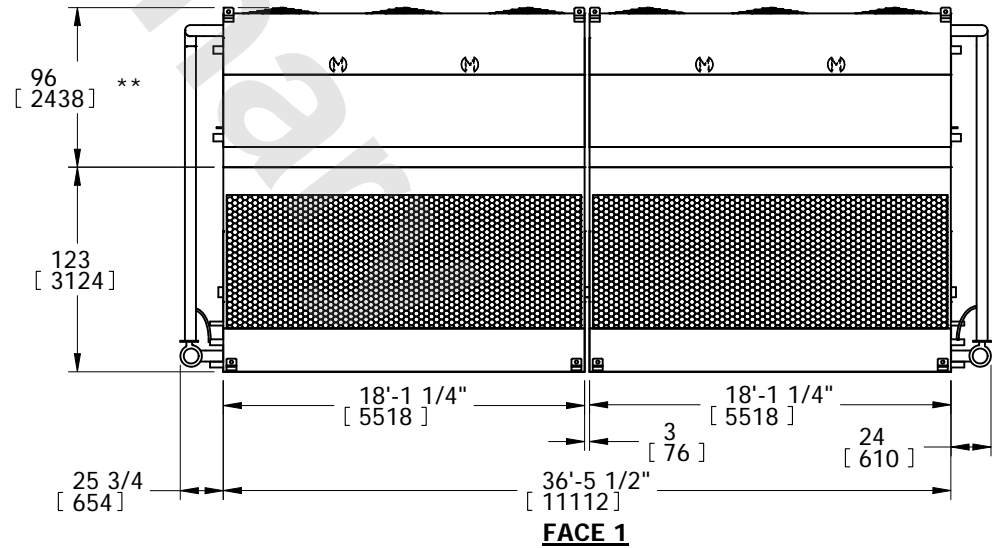
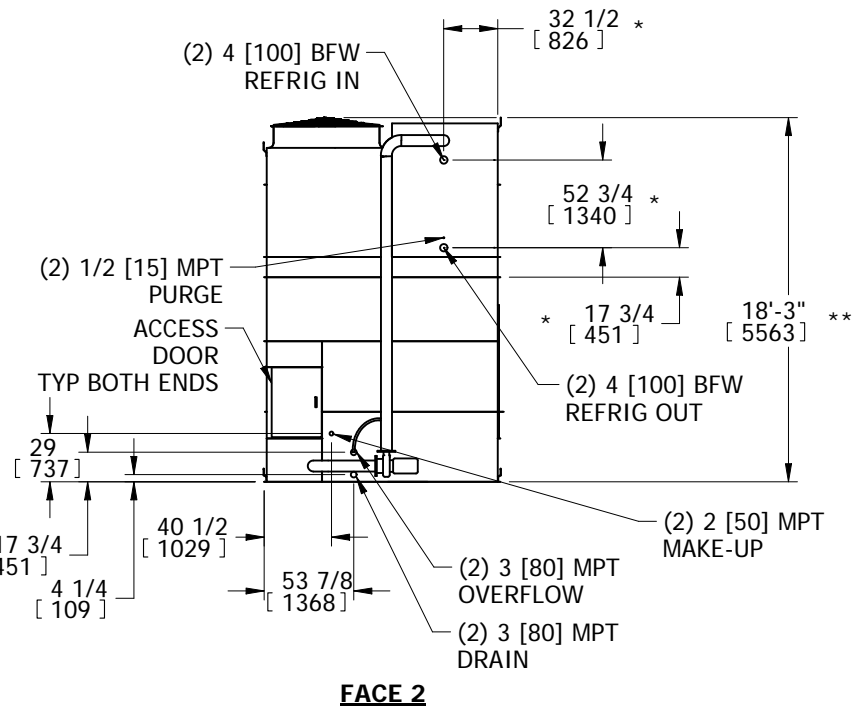

FACE 1

SHIPPING WEIGHT 45060 lbs+ [20440] kg+	OPERATING WEIGHT 61360 lbs+ [27835] kg+	HEAVIEST SECTION WEIGHT 15540 lbs+ [7050] kg+	NO. OF SHIPPING SECTIONS 4	DRAWN BY: TLS
---	--	--	-------------------------------	------------------