

# EVAPCO, INC.



|                                      |                      |       |                            |           |                   |          |
|--------------------------------------|----------------------|-------|----------------------------|-----------|-------------------|----------|
| UNIT<br><b>EVAPORATIVE CONDENSER</b> | MODEL #<br>PHC-D2050 | SCALE | DWG. #<br>HCD282614-DRC-ST | REV.<br>- | DATE<br>5/17/2026 | SERIAL # |
|--------------------------------------|----------------------|-------|----------------------------|-----------|-------------------|----------|

- NOTES:
- (M)- FAN MOTOR LOCATION
  - HEAVIEST SECTION IS UPPER SECTION
  - MPT DENOTES MALE PIPE THREAD  
FPT DENOTES FEMALE PIPE THREAD  
BFW DENOTES BEVELED FOR WELDING  
GVD DENOTES GROOVED
  - +UNIT WEIGHT DOES NOT INCLUDE ACCESSORIES (SEE ACCESSORY DRAWINGS)
  - MAKE-UP WATER PRESSURE  
20 psi MIN [137 kPa], 50 psi MAX [344 kPa]
  - 3/4" DIA. MOUNTING HOLES. REFER TO RECOMMENDED STEEL SUPPORT DRAWING.
  - \*- APPROXIMATE DIMENSIONS DO NOT USE FOR PRE-FABRICATION OF CONNECTION PIPING.
  - DIMENSIONS LISTED AS FOLLOWS: ENGLISH IN [METRIC] [mm]

**FACE 2  
PLAN VIEW**

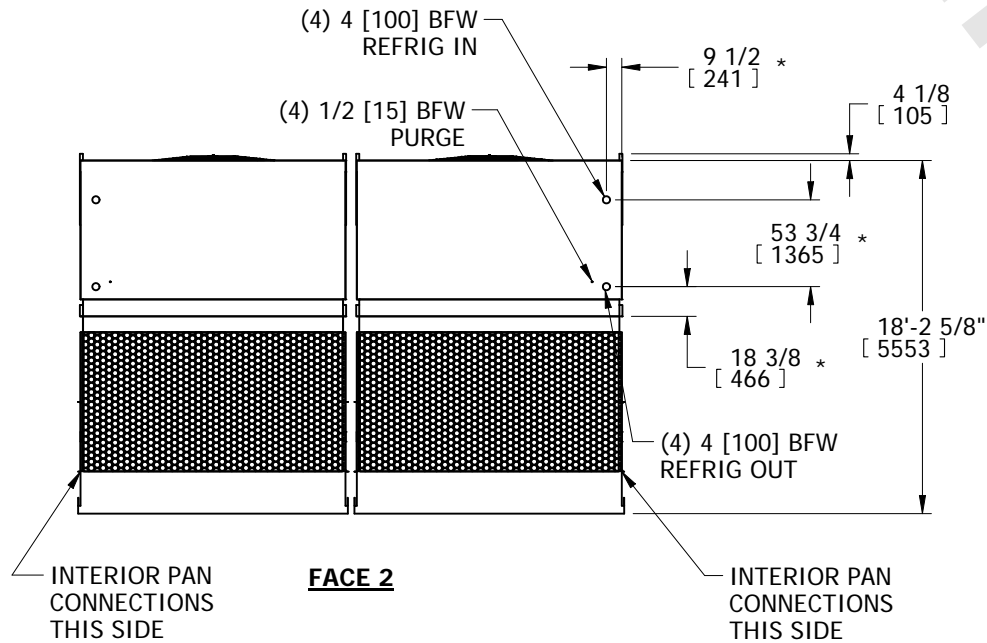
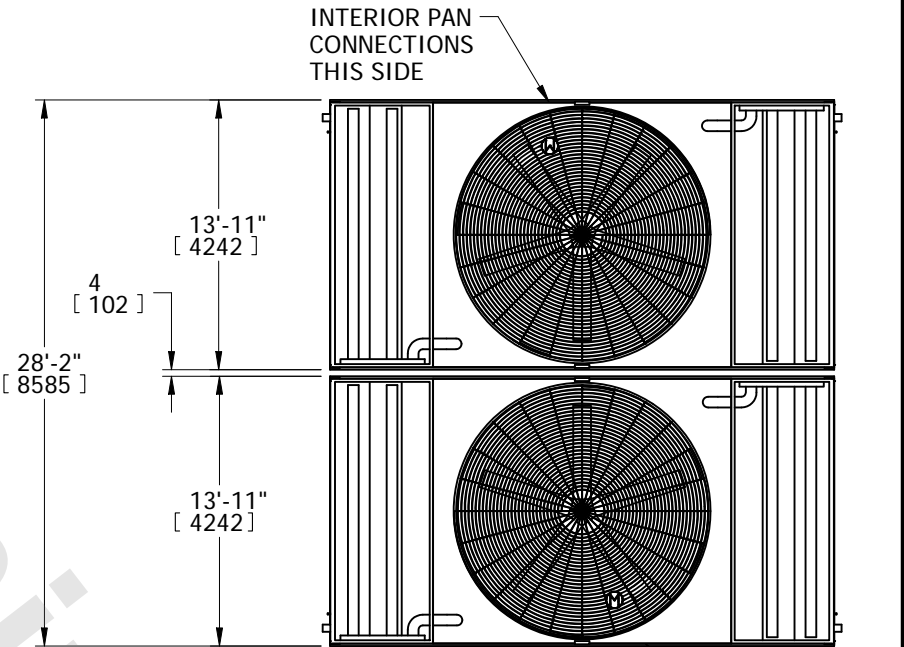

**FACE 2**

**FACE 1**

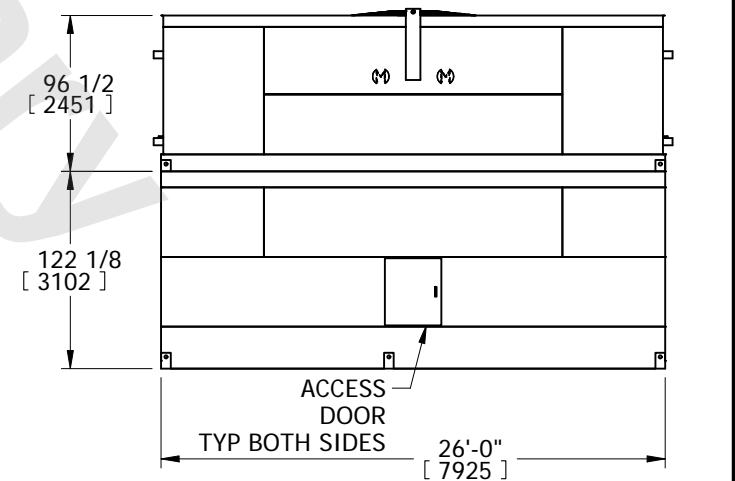

**FACE 1**

|   |   |   |                               |                  |
|---|---|---|-------------------------------|------------------|
| SHIPPING WEIGHT<br>79540 lbs+ [36080] kg+ | OPERATING WEIGHT<br>121660 lbs+ [55185] kg+ | HEAVIEST SECTION WEIGHT<br>28270 lbs+ [12825] kg+ | NO. OF SHIPPING SECTIONS<br>4 | DRAWN BY:<br>TLS |
|---|---|---|-------------------------------|------------------|