

**CONFIDENTIAL**  
 This document is the property of Evapco, Inc. It should not be copied or disclosed without prior written authorization.

**EVAPCO, INC.**



|          |                                  |                 |                             |        |                   |
|----------|----------------------------------|-----------------|-----------------------------|--------|-------------------|
| CUSTOMER | MODEL #<br>SSTLB3-6710VF0500K1LA | SCALE<br>N.T.S. | DWG. #<br>STL3-SE-16-10R-FL | REV. 1 | DATE<br>5/20/2026 |
|----------|----------------------------------|-----------------|-----------------------------|--------|-------------------|



NEMA 4X  
JUNCTION  
BOX

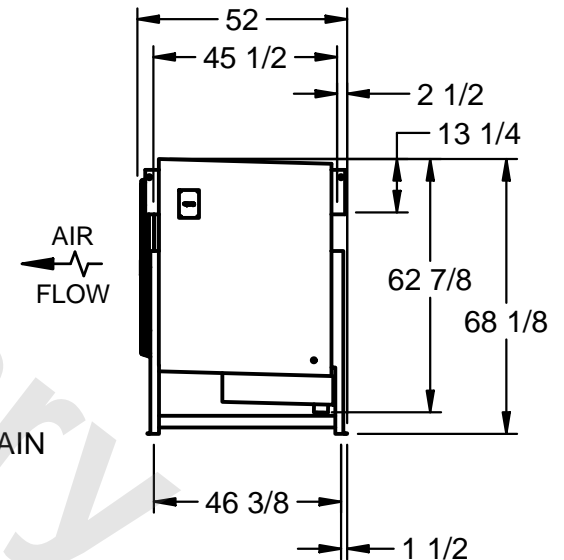
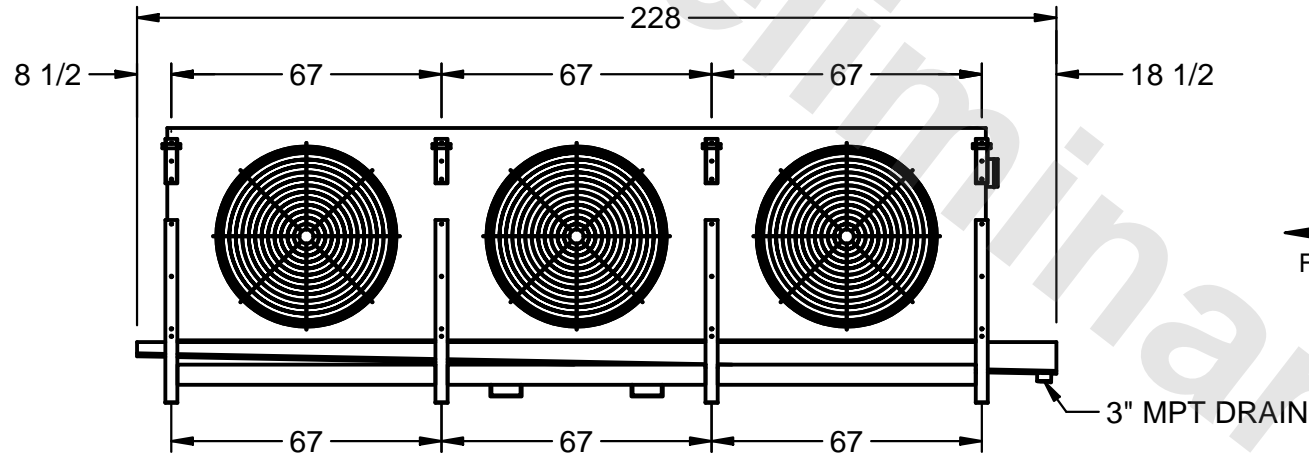

**NOTES:**

- 1) RIGHT HAND MODEL SHOWN.
- 2) ALL DIMENSIONS ARE FOR REFERENCE AND SHOULD NOT BE USED FOR PREFABRICATION OF PIPING OR SUPPORTS.
- 3) WATER DEFROST ADDS 6 INCHES TO HEIGHT OF STANDARD UNIT AND CHANGES DRAIN SIZE.
- 4) HANGER HOLES ARE FOR 3/4 INCH THREADED ROD.

|         |      |                          |                           |
|---------|------|--------------------------|---------------------------|
| PROJECT | ROOM | SHIPPING WEIGHT 4440 lbs | OPERATING WEIGHT 5270 lbs |
|---------|------|--------------------------|---------------------------|