

CONFIDENTIAL

This document is the property of Evapco, Inc. It should not be copied or disclosed without prior written authorization.

EVAPCO, INC.



CUSTOMER	MODEL # SSTWB2-19S84F0075F3KA	SCALE N.T.S.	DWG.# STWA2-SE	REV. 0	DATE 4/26/2026
----------	-------------------------------	--------------	----------------	--------	----------------

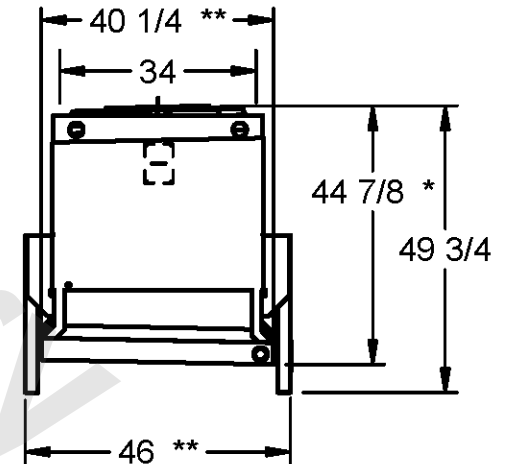

NOTES

- 1) ALL DIMENSIONS ARE FOR REFERENCE AND SHOULD NOT BE USED FOR PREFABRICATION OF PIPING OR SUPPORTS.
- 2) HANGER HOLES ARE FOR 3/4 INCH THREADED ROD.
- \* HOT GAS DEFROST ADDS 1/2 INCH TO THE HEIGHT OF A STANDARD UNIT, WATER DEFROST ADDS 6 INCHES TO THE HEIGHT OF A STANDARD UNIT AND CHANGES THE DRAIN SIZE
- \* TWO ROWS REHEAT ADDS 5.25 INCHES TO THE HEIGHT OF 6 AND 8 ROW DEEEP STANDARD UNITS.
- \* FOUR ROWS REHEAT ADDS 5.25 INCHES TO THE HEIGHT OF 4 AND 6 ROW DEEP STANDARD UNITS AND 8.75 INCHES TO THE HEIGHT OF 8 ROW DEEP STANDARD UNITS.
- \*\* EXTENDED WIDTH DRAIN PAN ADDS 6 INCHES TO THE WIDTH OF A STANDARD UNIT.

PROJECT	ROOM	SHIPPING WEIGHT 1040 lbs+ [475] kg+	OPERATING WEIGHT 1220 lbs+ [555] kg+
---------	------	-------------------------------------	--------------------------------------