

UNIT	CONDENSER	
MODEL #	eco-ATC-373A	SCALE NTS



DWG. #	EGTM1204-DRC-ST	REV.	-
SERIAL #		DATE	6/25/2026

NOTES:

- (M)- FAN MOTOR LOCATION
- HEAVIEST SECTION IS UPPER SECTION
- MPT DENOTES MALE PIPE THREAD
FPT DENOTES FEMALE PIPE THREAD
BFW DENOTES BEVELED FOR WELDING
GVD DENOTES GROOVED
FLG DENOTES FLANGE
PE DENOTES PLAIN END
- +UNIT WEIGHT DOES NOT INCLUDE ACCESSORIES (SEE ACCESSORY DRAWINGS)
- MAKE-UP WATER PRESSURE
20 psi MIN [137 kPa], 50 psi MAX [344 kPa]
- *-APPROXIMATE DIMENSIONS DO NOT USE FOR PRE-FABRICATION OF CONNECTING PIPING
- 3/4" [19mm] DIA. MOUNTING HOLES. REFER TO RECOMMENDED STEEL SUPPORT DRAWING.
- DIMENSIONS LISTED AS FOLLOWS:
ENGLISH FT-IN
METRIC [mm]

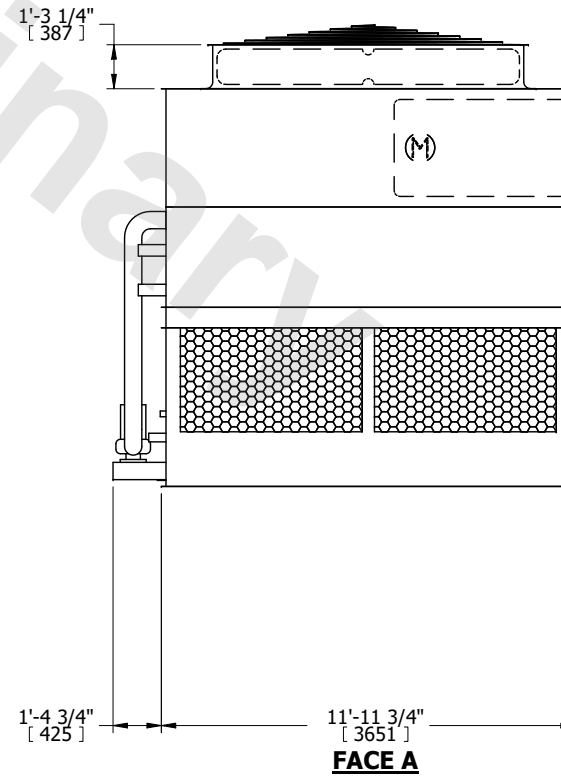
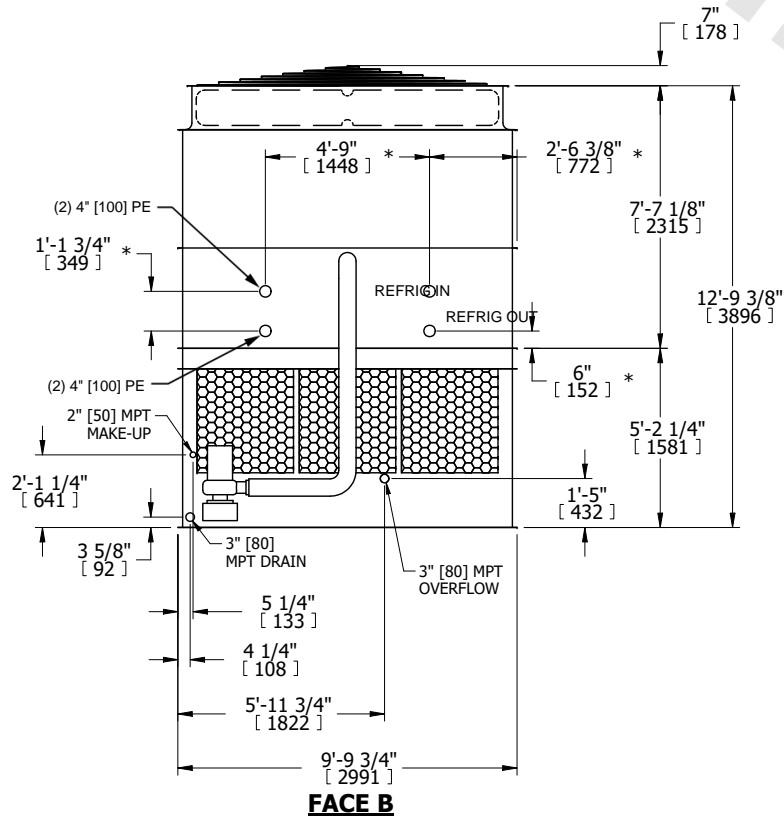
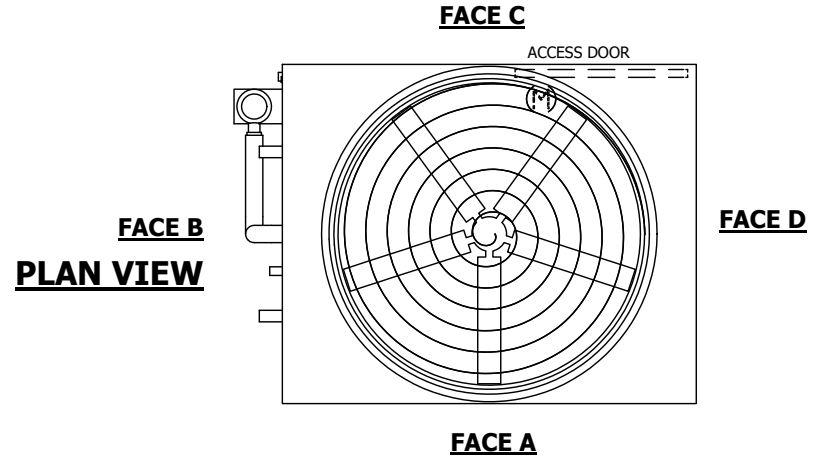

SHIPPING WEIGHT	12400 lbs+ [5625] kg+	OPERATING WEIGHT	18120 lbs+ [8220] kg+	HEAVIEST SECTION WEIGHT	9850 lbs+ [4470] kg+	NO. OF SHIPPING SECTIONS	2	DRAWN BY:	SLR
-----------------	-----------------------	------------------	-----------------------	-------------------------	----------------------	--------------------------	---	-----------	-----