

CONFIDENTIAL

This document is the property of Evapco, Inc. It should not be copied or disclosed without prior written authorization

EVAPCO, INC.



CUSTOMER	MODEL # SSTDB2-1984H0050F3KA-B	SCALE N.T.S.	DWG. # STD2-BT	REV. 0	DATE 4/5/2026
----------	--------------------------------	--------------	----------------	--------	---------------

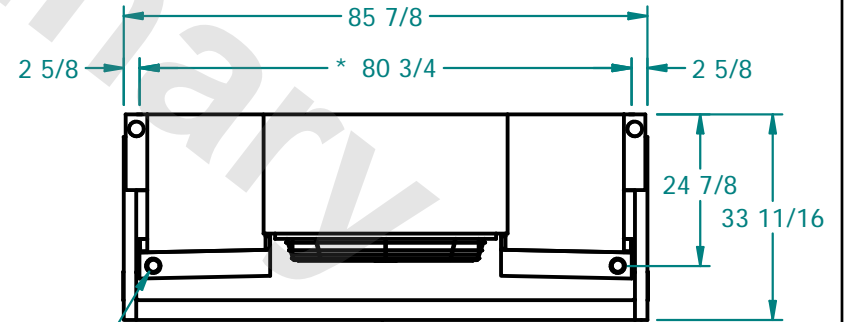

2.0" MPT DRAIN TYP. 2

AIR FLOW BLOW THROUGH

NOTES :

- 1) * = HANGER HOLE LOCATION.
- 2) ALL DIMENSIONS ARE FOR REFERENCE AND SHOULD NOT BE USED FOR PREFABRICATION OF PIPING OR SUPPORTS.
- 3) HANGER HOLES ARE FOR 3/4 INCH THREADED ROD.

PROJECT	ROOM	SHIPPING WEIGHT 1420 lbs	OPERATING WEIGHT 1600 lbs
---------	------	--------------------------	---------------------------