

CONFIDENTIAL

This document is the property of Evapco, Inc. It should not be copied or disclosed without prior written authorization.

EVAPCO, INC.



| | | | | | |
|----------|----------------------------------|-----------------|-----------------------------|--------|------------------|
| CUSTOMER | MODEL # SSTHB4-89124E0500K1LA | SCALE N.T.S. | DWG. # STL4-SE-16-10R-FL | REV. 1 | DATE 4/5/2026 |
|----------|----------------------------------|-----------------|-----------------------------|--------|------------------|

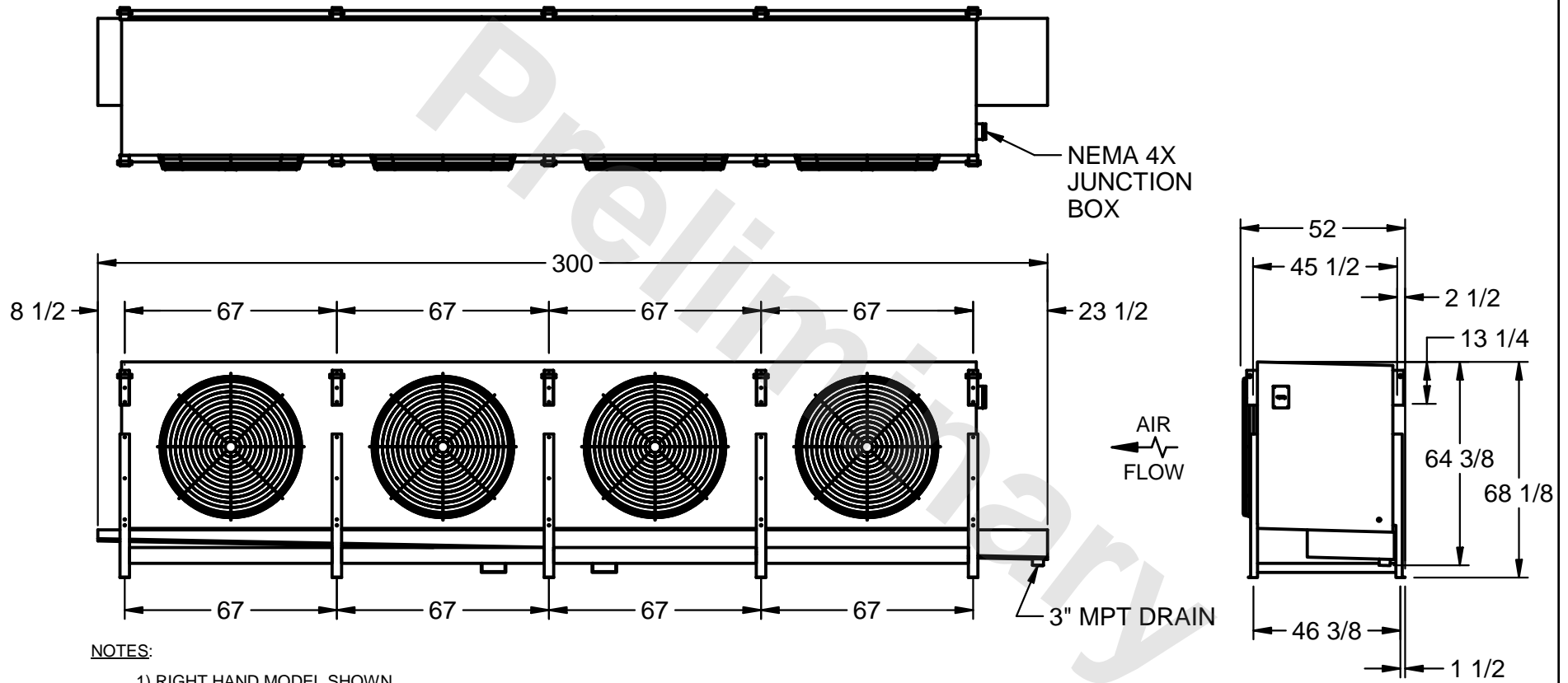

NOTES:

- 1) RIGHT HAND MODEL SHOWN.
- 2) ALL DIMENSIONS ARE FOR REFERENCE AND SHOULD NOT BE USED FOR PREFABRICATION OF PIPING OR SUPPORTS.
- 3) WATER DEFROST ADDS 6 INCHES TO HEIGHT OF STANDARD UNIT AND CHANGES DRAIN SIZE.
- 4) HANGER HOLES ARE FOR 3/4 INCH THREADED ROD.

| | | | |
|---------|------|--------------------------|---------------------------|
| PROJECT | ROOM | SHIPPING WEIGHT 6140 lbs | OPERATING WEIGHT 7700 lbs |
|---------|------|--------------------------|---------------------------|